

MIDLAND®



PRO901

RUGGED UHF CB
80CH MINI COMPACT

 **7 year**
warranty*

*5 year standard warranty.
To claim bonus 2 year warranty visit
www.midlandaustralia.com.au
to register your product.

CONTENTS

1. Introduction	3
2. What's Included.....	4
3. Emergency/Telecommand Channels	4
4. Control Panel Functions	5
5. Operation	6
6. Scanning for Active Channels.....	7
7. Selecting the Transmit TX Power Level.....	8
8. CTCSS Setting.....	9
9. DCS Setting.....	9
10. Duplex Operation.....	10
11. To Select the LCD Display Background.....	11
12. Frequency List.....	12
13. Specifications.....	14
14. Notes.....	15
15. Warranty.....	16

1. Introduction:

Thank you for purchasing this MIDLAND in-vehicle UHF Band CB radio. Please read this manual carefully to understand its functions and operations.

The PRO901 you purchased is an advanced UHF in-vehicle two way radio. PRO901 combines the very latest in electronic hardware with the most up-to date computer aided design and manufacturing techniques to produce an extremely compact mobile radio with outstanding specifications and performance.

PRO901 has front mounted controls and is designed for unobtrusive mounting in modern vehicles with limited space. Its innovative features include a built-in loud-speaker housed within an extremely compact case.

Note: The use of the Citizen Band radio service is licensed in Australia by ACMA Radio Communications (Citizen Band Radio Stations) Class license and in New Zealand by the Ministry of Economic Development New Zealand.

Thank you for your support and interest in our products!

Maintenance service and support

The Company provides long-term support for its products. This support includes maintenance, spare parts and warranty within the warranty period.

After the expiry of the warranty

The company provides technical services and spare parts to authorized radio dealers.

The ordering of replacement parts

When ordering replacement parts or equipment information, please specify the complete part code. All parts include part number, components or chassis. If you do not know the part code, please indicate the chassis or group that the part relates to.

Personal safety

For personal safety, please disconnect all power and RF cables before attempting any repair work.



All articles displaying this symbol on the body, packaging or instruction manual must not be thrown away in normal waste bins but should be placed in recycling bins or taken to a specialised waste disposal centre.



This symbol assures that a device complies with all applicable ACMA regulatory arrangements for radiocommunication equipment used in Australian UHF citizen band radio service.

What's Included:

Please carefully unpack the transceiver from the carton.
Please check that all accessories are included.

SPARE PARTS	UNITS	QUANTITY
In-vehicle radio	pc	1
Mounting bracket	pc	1
Microphone	pc	1
Microphone bracket	pc	1
User manual	pc	1
Power cable	pc	1
Screws	pc	1

Please contact the retailer if any parts are missing.

Emergency Channel

ACMA has pre-allocated channels 5/35. Channel 5 is only for emergency application. Channel 5 repeater access is available in most areas. Activate duplex on Channel 5.

Telecommand Channels

ACMA has reserved Channel 22 and Channel 23 as telecommand channels. Transmission is prohibited on these channels. PRO901 blocks transmission on these 2 channels. Channels 61, 62 and 63 are for future use and TX is inhibited on these channels.

Control Panel Functions:

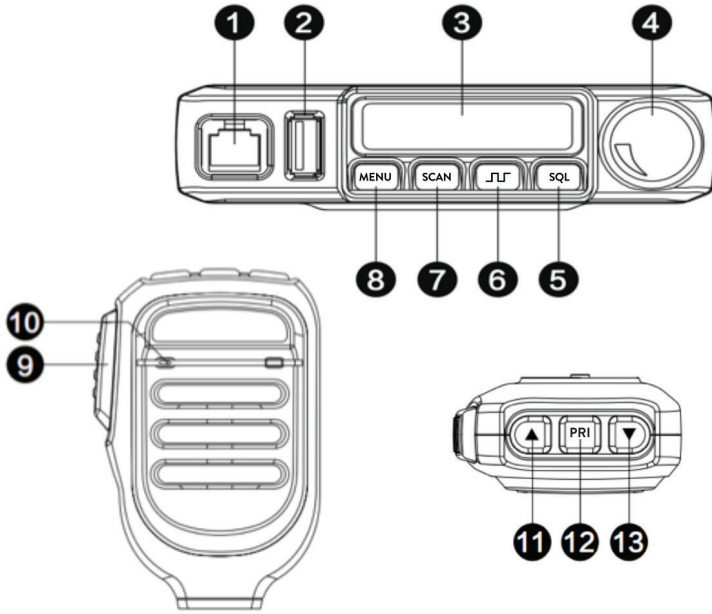

No	Description/ Function	Short Press	Long Press
1	MIC jack		
2	USB Charging Port		
3	LCD displays		
4	Volume & On/Off		
5	Squelch Function	Enter Squelch function then adjust via up/down mic buttons	
6	CTCSS/DCS Tone	CTCSS tone menu	DCS tone menu
7	Scan key	Turn on scan function	
8	MENU key	Enter the function selection menu	
9	PTT		
10	MIC		
11	Channel Up	Channel Up	Channel continuous Up
12	PRI	Recall PRIORITY CH	Setting PRIORITY CH
13	Channel Down	Channel Down	Channel continuous down

Operation:

Power On/Off:

Once professionally installed -

Rotate the Knob to the right to turn on.

You will hear a tone to indicate that the radio is on.

The LCD display will show all icons for one second and then display the most recently selected channel.

When the radio is on, turn the knob counter clockwise all the way to turn off.

The LCD display will go blank when the radio turns off.



Adjusting the Volume:

Turn the Volume knob clockwise to increase the volume or turn the Volume knob counter clockwise to decrease the volume.

Selecting an Active Channel:

IMPORTANT!

To communicate between two radios, both radios must be set to the same channel.

Be sure the radio is turned on (See Power On/Off)

1. Press and release the Channel Up button ▲ (11) or the Channel Down button ▼ (12) on the microphone to scroll through the available channels.

2. Press and release the SCAN button (7) to rapid scan to find active channels.

The Channel icon on the LCD display will show the active channel.



Scanning for Active Channels:

The PRO901 includes an "auto-scan" mode that continuously scans all 80 available channels for activity.

To enter and exit "auto-scan" mode:

1. Be sure the radio is turned on. (see Power On/Off)

2. Press and release the Scan button to enter "auto-scan" mode.

The Scanning icon will show on the LCD display when the radio is in "auto-scan" mode. The radio will rapidly scan through the 80 available channels and will pause on any active channel.

"Auto-scan" will resume when there has been no activity on the current channel for four seconds.

3. To transmit during "auto scan," press and hold the PTT button on the microphone while the radio is paused on the desired channel.

The radio will remain on the active channel for three seconds after the PTT button is released.

4. To exit the "auto-scan" mode, press and release the Scan button.

The Scanning icon will turn off when the radio is no longer in "auto-scan" mode.



Transmitting and Receiving a Call:

IMPORTANT!

To communicate between two radios, both radios must be set to the same channel (see Selecting a Privacy Code) selections.

To transmit and receive a call:

1. Be sure the radio is turned on. (see Power On/Off)

2. To transmit a call, press and hold the PTT button (9) on the microphone, and speak into the microphone in a normal voice.

NOTE: For maximum clarity, hold the microphone 2 to 3 inches from your mouth when speaking.

The TX icon will show continuously on the LCD display while transmitting.



3. To receive a call, release the PTT (9) button on the microphone.

The RX icon will show on the LCD display when your radio is receiving a transmission.



Selecting the Transmit (TX) Power Level:

The PRO901 provides two transmit power levels; HI (5W) and Lo (0.5W).

The Lo power level is generally suitable when operating under optimum conditions and in closer range. This is also useful in not picking up other users that are further away.

The HI power level is recommended to ensure you get maximum range from your radio.

To Adjust the Transmit Power Level:

1. Press and release the Menu button (8) to place the radio in "Menu" mode.
2. Use the Channel Up (11) or Channel Down (13) buttons to scroll the menu options until the LCD display shows Pr.
3. Press the SQL (5) button to confirm your selection.
4. Use the Channel Up ▲ or Channel Down ▼ button to toggle the transmit power setting between HI and Lo.
5. When the desired transmit power level is shown on the LCD display, press the SQL button to confirm your selection.

Note: YOU MUST PRESS THE SQL BUTTON TO CONFIRM YOUR SELECTION, OR THE POWER LEVEL WILL NOT BE CHANGED.

Adjusting Squelch Sensitivity:

The PRO901 has adjustable squelch sensitivity. The minimum squelch level of 00 is the most sensitive, which allows the squelch to open on very weak signals. Setting the squelch to the maximum setting of 09 requires very strong signals to open the squelch.

To Adjust the Squelch Sensitivity:

1. Press the SQL (5) button to set SQ Level.
2. Use the Channel Up ▲ or Channel Down ▼ button to scroll forward or backward to select the desired squelch level, from 0F to 09.
3. Press the SQL button to confirm your selection

The default squelch setting is 05, which generally provides reliable squelch operation for most applications.

NOTE: YOU MUST PRESS THE SQL BUTTON TO CONFIRM YOUR SELECTION OR THE SQUELCH SENSITIVITY WILL NOT BE CHANGED.

Selecting a Privacy Code:

Continuous Tone Coded Squelch System (CTCSS) and Digitally Coded Squelch (DCS) are systems that allow several users to share the same channel without disturbing each other. When CTCSS or DCS is enabled for a selected channel, the channel is muted to all incoming signals unless they carry the correct CTCSS or DCS tone.

When a transmission with the correct tone is received, the mute is removed and the voice audio can be heard. When the transmission ends the channel is muted again.

Transmissions that do not have the correct tone are not heard.

The PRO901 has 154 Privacy Codes (50 CTCSS codes and 104 DCS codes), which can be applied to any channel. If desired, you can select a different Privacy Code for each channel. See *CTCSS Privacy codes Frequency Chart* and *DCS Privacy Codes Chart* for lists of available Privacy Codes.

To select a Privacy Code:

CTCSS Setting

Press and release the CTCSS/DCS (6) button to set CTCSS.

The  (for CTCSS) icon will show on the LCD display, according to your selection.

Use the Channel Up  or Channel Down  button on the Mic to scroll forward or backward through the available Privacy Codes until the desired Privacy Code is shown on the LCD display.

DCS Setting



Press and hold the CTCSS/DCS (6) button for 3 seconds to set DCS.

The  (for DCS) icon will show on the LCD display, according to your selection.

Use the Channel Up  or Channel Down  button on the Mic to scroll forward or backward through the available Privacy Codes until the desired Privacy Code is shown on the LCD display.

NOTE: DCS Privacy Codes 100-104 are shown on the LCD display as A0-A4.

NOTE: Selecting a Privacy Code of "OF" will disable the Privacy feature.

SYMBOL	MODE
	CTCSS
	DCS
OFF	No CTCSS/DCS

Programming the Priority Channel:

Press  /  to select the Priority Channel you prefer.

Press and hold PRI button on the microphone for 3 seconds to store the new setting.

When the channel is selected as a Priority Channel, the channel display will flash.



Recall the Priority Channel:

Momentarily press the PRI button on the microphone at any time to return to the Instant Channel. Press PRI again to return to the previous channel.

Roger Beep:

When the PTT button on the mic is released, the radio will beep to confirm to other users that your transmission is complete

To Activate:

1. Press and release the Menu button to place the radio in "Menu" mode.
2. Use the Channel Up  or Channel Down  button on the Mic to scroll through the menu options until the LCD display shows rb.

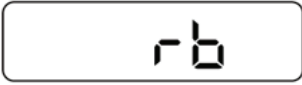

3. Press the **SQ** button to confirm your selection.
4. Use the Channel Up ▲ or Channel Down ▼ button on the Mic to select ON or OFF.
5. When the desired selection is shown in the LCD display press the SQL button to confirm your selection.

NOTE: YOU MUST PRESS THE SQ BUTTON TO CONFIRM YOUR SELECTION OR THE ROGER BEEP WILL NOT BE CHANGED.

Silent Operation:

The PRO901 has a SILENT OPERATION mode. In this mode, all “beeps” and “tones” are disabled.

To Set the Silent Operation:

1. Press and release the Menu button to place the radio in “Menu” mode.
2. Use the Channel Up ▲ or Channel Down ▼ button on the Mic to scroll through the menu options until the LCD display shows bP.



3. Press the **SQL** button to confirm your selection.
4. Use the Channel Up ▲ or Channel Down ▼ button on the Mic to select ON or OFF.
5. When the desired selection is shown on the LCD display, press the SQL button to confirm your selection.

NOTE: YOU MUST PRESS THE SQ BUTTON TO CONFIRM YOUR SELECTION OR THE SILENT. OPERATION SELECTION WILL NOT BE CHANGED.

Duplex Operation:

Duplex operation allows the radio to transmit on a different frequency to that which it receives allowing operation through repeater stations, Repeaters automatically re-transmit your signal over a wider area, providing greatly increase range.

To Select Duplex on individual Channels

1. Press and release the Menu button to place the radio in “Menu” mode.
 2. Use the Channel Up ▲ or Channel Down ▼ button on the Mic to scroll through the menu options until the LCD display shows rP.
- Push the MENU, press ▲ or ▼ on the Mic to select channel repeat that you want (1/8 or 41/48) press SQL button to set RP channel and confirm by pressing the MENU button (the display shows RP icon).

Selecting the LCD Display Background Color:

Your PRO901 has 8 different colour options for the LCD Display background.

To Select the LCD Display Background:

1. Press and release the Menu button to place the radio in "Menu" mode.
2. Use the Channel Up ▲ or Channel Down ▼ button on the Mic to scroll through the menu options until the LCD display shows db.



3. Press the **SQL** button to confirm your selection.
4. Use the Channel Up ▲ or Channel Down ▼ button on the Mic to select the LCD Display background color (01 - 08).

Restoring to Default Settings:

You can restore the original (factory default) settings for your PRO901 at any time.

1. Be sure the radio is turned off (see Power On/Off).
 2. Press and hold the PTT (9) and the SQL (5) button simultaneously.
 3. With the PTT and SQL buttons still held, turn on the radio.
- All user settings will be cleared, returning the radio to all default settings.



Default Settings Reset Table

Power Level	Hi	CTCSS/DCS	OFF
BackLight	05(Blue)	Beep	ON
RogerBeep	ON	SQL	05
Repeater CH	OFF	PRIORITY CH	None

Frequency List:

CH	Simplex Mode Frequency (MHz)	Duplex Mode Frequency (MHz)	CH	Simplex Mode Frequency (MHz)	CH	Simplex Mode Frequency (MHz)	Duplex Mode Frequency (MHz)	CH	Simplex Mode Frequency (MHz)
01	476.4250	477.1750 (CH31) Repeater TX	21	476.9250	41	476.4375 Repeater RX	477.1875 (CH71) Repeater Transmit	61	476.9375 (RX Only) Future Use
02	476.4500	477.2000 (CH32) Repeater TX	22	476.9500 Data Only	42	476.4625 Repeater RX	477.2125 (CH72) Repeater Transmit	62	476.9625 (RX Only) Future Use
03	476.4750	477.2250 (CH33) Repeater TX	23	476.9750 Data Only	43	476.4875 Repeater RX	477.2375 (CH73) Repeater Transmit	63	476.9875 (RX Only) Future Use
04	476.5000	477.2500 (CH34) Repeater TX	24	477.0000	44	476.5125 Repeater RX	477.2625 (CH74) Repeater Transmit	64	477.0125
05	476.5250 Emergency Only	477.2750 (CH35) Repeater TX	25	477.0250	45	476.5375 Repeater RX	477.2875 (CH75) Repeater Transmit	65	477.0375
06	476.5500	477.3000 (CH36) Repeater TX	26	477.0500	46	476.5625 Repeater RX	477.3125 (CH76) Repeater Transmit	66	477.0625
07	476.5750	477.3250 (CH37) Repeater TX	27	477.0750	47	476.5875 Repeater RX	477.3375 (CH77) Repeater Transmit	67	477.0875
08	476.6000	477.3500 (CH38) Repeater TX	28	477.1000	48	476.6125 Repeater RX	477.3625 (CH78) Repeater Transmit	68	477.1125
09	476.6250		29	477.1250	49	476.6375		69	477.1375
10	476.6500		30	477.1500 UHF CB Broadcast	50	476.6625		70	477.1625
11	476.6750 Call Channel		31	477.1750 Repeater Input	51	476.6875		71	477.1875 Repeater Input
12	476.7000		32	477.2000 Repeater Input	52	476.7125		72	477.2125 Repeater Input
13	476.7250		33	477.2250 Repeater Input	53	476.7375		73	477.2375 Repeater Input
14	476.7500		34	477.2500 Repeater Input	54	476.7625		74	477.2625 Repeater Input
15	476.7750		35	477.2750 Emergency Only	55	476.7875		75	477.2875 Repeater Input
16	476.8000		36	477.3000 Repeater Input	56	476.8125		76	477.3125 Repeater Input
17	476.8250		37	477.3250 Repeater Input	57	476.8375		77	477.3375 Repeater Input
18	476.8500		38	477.3500 Repeater Input	58	476.8625		78	477.3625 Repeater Input
19	476.8750		39	477.3750	59	476.8875		79	477.3875
20	476.9000		40	477.4000 Highway Channel	60	476.9125		80	477.4125

CTCSS:

01	67.0	11	94.8	21	131.8	31	171.3	41	203.5
02	69.3	12	97.4	22	136.5	32	173.8	42	206.5
03	71.9	13	100.0	23	141.3	33	177.3	43	210.7
04	74.4	14	103.5	24	146.2	34	179.9	44	218.1
05	77.0	15	107.2	25	151.4	35	183.5	45	225.7
06	79.7	16	110.9	26	156.7	36	186.2	46	229.1
07	82.5	17	114.8	27	159.8	37	189.9	47	233.6
08	85.4	18	118.8	28	162.2	38	192.8	48	241.8
09	88.5	19	123.0	29	165.5	39	196.6	49	250.3
10	91.5	20	127.3	30	167.9	40	199.5	50	254.1

DCS:

01	023	19	116	37	225	55	325	73	452	91	627
02	025	20	122	38	226	56	331	74	454	92	631
03	026	21	125	39	243	57	332	75	455	93	632
04	031	22	131	40	244	58	343	76	462	94	654
05	032	23	132	41	245	59	346	77	464	95	662
06	036	24	134	42	246	60	351	78	465	96	664
07	043	25	143	43	251	61	356	79	466	97	703
08	047	26	145	44	252	62	364	80	503	98	712
09	051	27	152	45	255	63	365	81	506	99	723
10	053	28	155	46	261	64	371	82	516	A0	731
11	054	29	156	47	263	65	411	83	523	A1	732
12	065	30	162	48	265	66	412	84	526	A2	734
13	071	31	165	49	266	67	413	85	532	A3	743
14	072	32	172	50	271	68	423	86	546	A4	754
15	073	33	174	51	274	69	431	87	565		
16	074	34	205	52	306	70	432	88	606		
17	114	35	212	53	311	71	445	89	612		
18	115	36	223	54	315	72	446	90	624		

Specifications:

- Output Power:	5 Watts (@13.8V)
- CB Channels:	RX/TX: 80
- CB Frequency Range:	476.425 ~ 477.4125MHz
- Channel Width:	12.5kHz (narrowband)
- Power Source:	9.5 – 16.5V
- Microphone:	MK901 w RJ45 Connector
- Base Speaker Power:	3.7W Max (@1KHz)
- Digital Coded Squelch (DCS):	104
- Interference Eliminator CTCSS:	50
- Dealer Programmable Receive CH:	19
- USB Charging Port:	Yes
- Duplex Capability:	Yes
- Channel Memory Scan:	Yes
- LCD Display:	Segment
- Backlit LCD & Keypad:	Yes
- Flip LCD:	No
- Slide-In Mounting Cradle:	Yes
- External Speaker Jack:	Yes
- TX/RX Indicator:	Yes
- Scanning Receive Functions:	Yes
- Key Lock:	Yes
- Key Beep On/Off:	Yes
- Auto Squelch:	Yes
- Typical Range:	18km Line of Sight
- Max absorption current in TX:	1.3A
- Dimensions (excl. Bracket):	120W x 25H x 110D mm

Included:

- Mounting Bracket
- Mic Hanger
- DC Power Cord

Notes:

WARRANTY

Congratulations on your purchase of a quality **MIDLAND** Mobile Communication Product! You're joining thousands of satisfied customers who enjoy & experience the benefits of the products we distribute. In the unlikely event that some technical difficulty arises with your purchase, be assured that we are most anxious to see that the problem is quickly rectified to your satisfaction. Please familiarise yourself with the following simple conditions of our warranty. This warranty covers faults through component failure or failure of the product to operate in accordance with published specifications. Product failure as a result of unreasonable environmental conditions, accident, misuse, improper installation, unauthorised repair, vehicle electrical or wiring faults or neglect etc, will not be covered by this warranty. Removal and installation costs, if any, would be paid by the owner as well as any freight or postage costs of transporting the product to AudioXtra. AudioXtra shall not be liable or responsible for any loss of use of this product or any form of consequential loss.

CONSUMER WARRANTY

This product is warranted by AudioXtra Pty Ltd to be free from defects in materials and workmanship under **NORMAL USE** for a period of **FIVE YEARS** from the date of purchase. The battery and accessories are warranted for **TWELVE MONTHS**. To claim bonus 2 year warranty visit www.midlandaustralia.com.au to register your product.

WITHIN 30 DAYS OF PURCHASE DATE:

Please return the unit for replacement to our National Service Centre or the Retailer from where you made the purchase. All accessories must be included. Proof of purchase date **must** accompany the products.

AFTER 30 DAYS OF PURCHASE DATE:

Warranty repair and service is carried out by our National Service Centre. Repair and service will be carried out at no cost to the owner if proof of ownership and the date of purchase can be verified to the satisfaction of the authorised centre concerned with this repair. This proof should take the form of either:

- The warranty card accompanying this product, stamped and dated by the dealer.
- A Tax Invoice or Receipt showing full details of original vendor, purchaser, model number and serial number.

COMMERCIAL WARRANTY

A product used in or associated with a commercial application will carry a limited SIX MONTH warranty. An abnormal commercial application is one where usage, dust, vibration, heat/cold and other environmental conditions exist at an extreme level.

Our goods come with guarantees that cannot be excluded under the Australian Consumer Law. You are entitled to a replacement or refund for a major failure and for compensation for any other reasonably foreseeable loss or damage. You are also entitled to have the goods repaired or replaced if the goods fail to be of acceptable quality and the failure does not amount to a major failure.

Please complete details below in the event of warranty service being required.

Purchaser's Name: _____

Purchaser's Address: _____

Model Number: **PRO901** _____ **Serial Number:** _____

Dealer Name: _____ **Date of Purchase:** / /

Dealer Address: _____

Invoice/Sales Docket no: _____

General Hints: To expedite service and prompt return of the equipment, please:

- Clearly describe the fault in detail
- Safely and securely pack the unit for transport
- Include your return address
- Provide proof of purchase date as outlined above

National Service Centre:

10 STODDART ROAD, PROSPECT, SYDNEY NSW 2148 Australia
Telephone: (02) 8841 9000 Fax: (02) 9636 1204
email: services@audioxtra.com.au

audioXtra PTY LTD
audioxtra.com.au