

Uniden®

UH5000

Mini Compact
UHF CB Transceiver

For more exciting new products please visit our website:
Australia: www.uniden.com.au

OWNER'S MANUAL

Contents

Introduction	3
Controls & Connectors	4
Indicators	6
Included with your UH5000 Transceiver	7
Connecting the Microphone	8
Mounting the MIC Hanger	9
Operation	10
Turning on the Power	10
Setting the Squelch Level	10
Monitor	12
Selecting a Channel	12
Programming the Instant Priority Channel	12
Recalling the Instant Channel	13
Transmitting	13
Call Function	13
Using Repeater Channels	13
Operating the UHF CB Radio in Duplex Mode	15
Scanning	15
Open Scan (OS) Mode	16
Group Scan (GS) Mode & Priority Watch	16
Add/Remove Channels from SCAN Memory	17
CTCSS & DCS	17
Busy Channel Lockout	18
Selecting the Call tone	18
Roger Beep	19
Beep On/Off	19
Backlight Colours	19
Backlight Brightness	20
LCD Flip	20
CTCSS Codes Table	21
DCS Codes Table	22
UHF CB Channel Guidelines	23
UHF CB Channels & Frequencies	24
Warranty	26

Introduction

The Uniden UH5000 is designed to provide you with years of trouble free service. Its rugged components and materials are capable of withstanding harsh environments. Please read this Operating Manual carefully to ensure you gain the optimum performance of the unit.



NOTE

The citizen band radio service is licenced in Australia by ACMA Radio-communications (Citizen Band Radio Stations) Class Licence and in New Zealand by MED General User Licence for Citizen Band Radio and operation is subject to conditions contained in those licenses.

Features

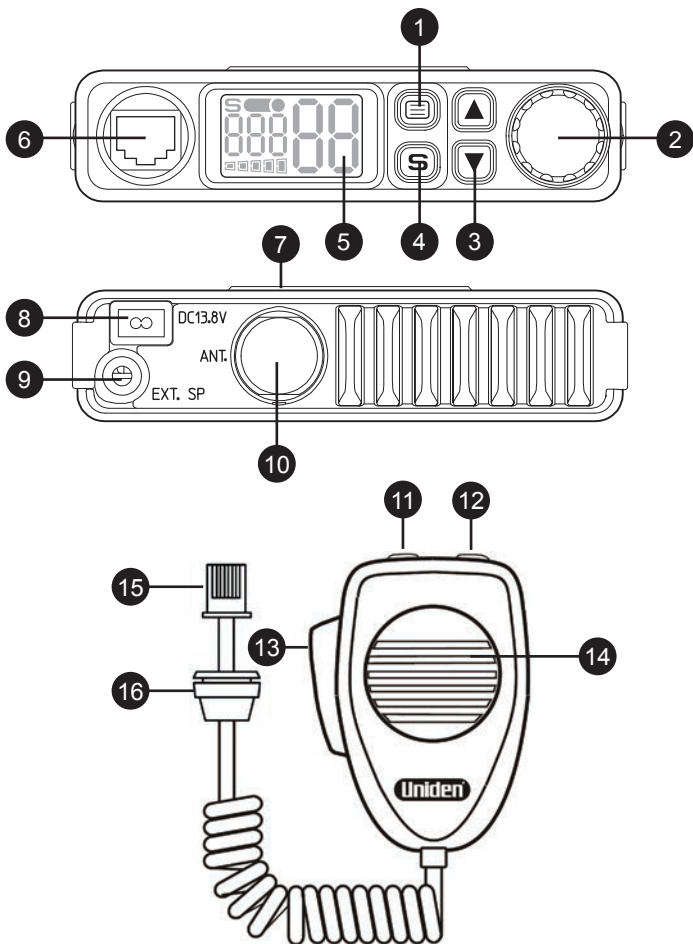

- Narrow Band (NB) 80 Channel Radio*
 - 12V DC Power Input
 - Built-in AVS Circuitry†
 - Transmission power 5W
 - LCD display
 - Signal strength and RF power (S/RF) meter
 - Instant channel programming
 - One touch Instant channel recalling
 - Selectable scanning type from group scan (GS) and open scan (OS).
 - Scan channel memory On/Off function separately divided into OS and GS
 - Monitor On/Off function
 - Duplex capability*
 - Key Beep On/Off function
 - Rotary Channel select knob
 - Busy Channel lock-out function
 - Roger beep function On/Off
 - 5 different CALL Tones
 - 38 built in CTCSS (Continuous Tone Coded Squelch System) codes and 104 DCS (Digital Coded Squelch) are selectable
 - Auto squelch detection threshold control (“oF”, “1” ~ “9”)
 - Volume control (“oF”, “1” ~ “40”)
 - Power On/Off control SW
 - Optional External Speaker
 - Flip LCD function
 - 7 LCD/Key Backlight Colour Options
 - 4 LCD/Key Backlight Brightness Levels
 - Under and over voltage alert function
- * Refer to p.23 - p.25 for channel information
- † AVS - Automatic Volume Stabilizer detects and manages incoming audio to comparable levels.

Controls & Connectors



Controls & Connectors

- 1  Menu Button
/ Monitor function
(press & hold)
- 2 PUSH control - Squelch
Select (press)
/Power On/Off (press & hold)

ROTARY control - CHANNEL
Selector
- 3  /  - Volume Up/Down
control
- 4  Channel Scan button
/ Scan Memory
(press & hold)
- 5 Liquid Crystal Display (LCD)
- 6 MIC - Front Microphone Jack
- 7 Speaker
- 8 Power Input Connection
(13.8VDC)
- 9 **EXT SP** - External Speaker
Jack
- 10 UHF Antenna Connection
- 11 **CALL** - Call Tone Button
- 12 **INST** - Instant Channel
Button
- 13 **PTT** - Push To Talk Button
- 14 MICROPHONE
- 15 RJ45 type plug
- 16 Front MIC Jack Cover

Indicators

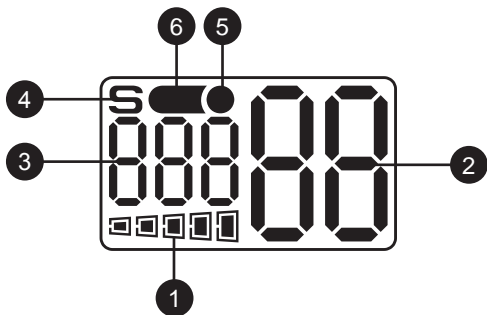

①  - Receive Signal Level (Channel Busy Indicator)

 - Transmit Signal Power Level

②  - Channel Number / Menu Item Setting

③  - CTCSS/DCS Code number / Menu Item

④  - Scan mode

⑤  - Channel in Memory

⑥  - Instant Channel

Included with your UH5000 Transceiver



Microphone

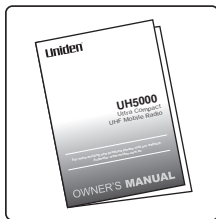

Owner's Manual

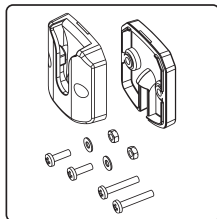

Microphone Hanger
with screws, washers

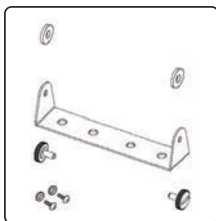

Mounting Bracket with
mounting screws

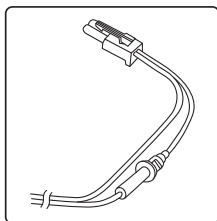

DC Power Cord
with fuse

Optional Accessories:

- UHF Antenna
- External Speaker

Visit the UH5000 page on the website for more information on the availability of optional accessories;
www.uniden.com.au for Australia

Connecting the Microphone

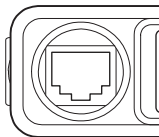

MIC Jack

Push the MIC plug at the end of the microphone into the MIC jack until the connection locks into place. Gently tug the MIC cord to test that the connection is locked. Use the rubber cover which is on the MIC cord to seal the MIC jack entry from dust.

Disconnecting the MIC from the MIC Jack

Pull back the rubber cover and move it down along the cord. Using the flat blade of a screwdriver or similar object carefully push the lock tab of the MIC plug towards the MIC cord and at the same time tug on the MIC cord to draw back the MIC plug.

Mounting the MIC Hanger

The Microphone Hanger comes in two parts. How and where you mount the MIC hanger will determine which parts to use.

Conventional Mounting with Screws

Use the front part of the MIC Hanger only. Locate a suitable mounting position and mark and drill two 3mm holes. Fix the MIC Hanger into place with screws.

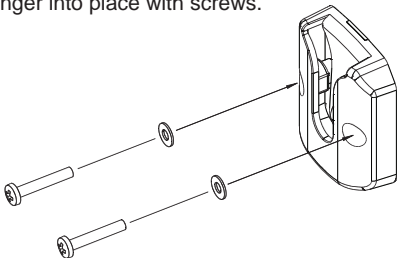

Conventional Mounting with Double Sided Tape (not supplied)

High quality Double-Sided tape can be found at good retail stores. Secure the front and back pieces of the MIC Hanger using the supplied binding screws.

Locate a suitable mounting position. Apply high quality Double-Sided tape onto the flat area of the MIC Hanger back piece and then press firmly to the mounting position.

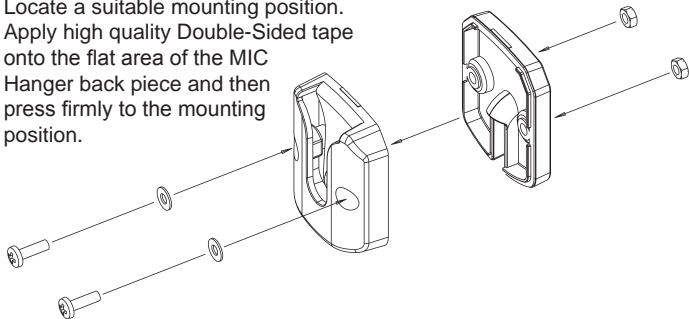

Operation

Turning on the Power

Press and hold the Power/Channel Selector.

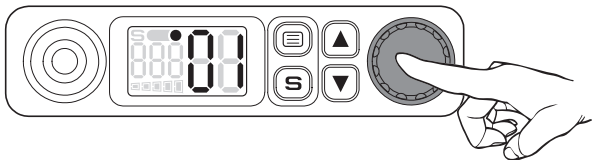

Low-Voltage/High-Voltage Alert

If the power supply voltage exceeds 18VDC, an alert tone sounds and **dc HI** flashes for 5 seconds. The power source must not exceed 25VDC otherwise permanent damage may occur to your radio, which may not be covered by the manufacturer's warranty.



NOTE

If the input voltage falls below 10VDC, **dc Lo** flashes for 5 seconds. The power turns off automatically if voltage falls below 8.5VDC.

Switch your UH5000 OFF and disconnect it from the power source, before locating the cause of the power supply problem.

Setting the Squelch Level

Press the Power/Channel Selector momentarily. **SqL** shows and the current squelch level will flash.

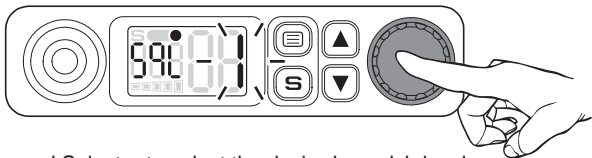

Turn the Channel Selector to select the desired squelch level.

Operation

oF(off) - squelch open.

1 - max sensitivity (min squelch)

5 - med sensitivity (med squelch)

9 - min sensitivity (max/tight squelch)



NOTE

You must select a channel which is not in use before setting the SQUELCH control. (see p.12 for “Selecting a Channel”).

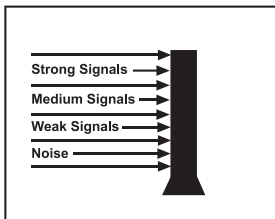

Think of the squelch control as a gate. If you increase the squelch level to maximum it raises the ‘Squelch gate’ so only the strongest signals get through.

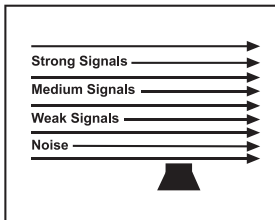

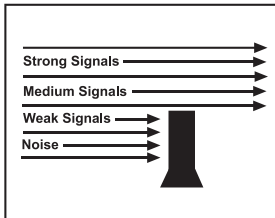

If you decrease the squelch level to minimum it lowers the ‘Squelch Gate’ to the extent that weak signals can get through.



If unwanted weak and noisy signals are getting through increase the squelch level (‘Squelch Gate’) to a medium level. Now only medium and strong signals get through.

Operation

Monitor

Press and hold  to open the squelch and receive all weak signals.
Press and hold  again to cancel.



Selecting a Channel

Turn the Channel Selector to select the desired channel.

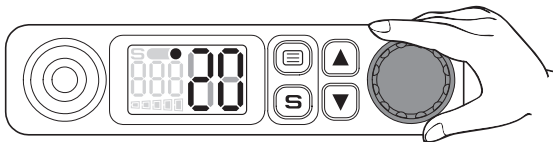

For your reference a list of the available channels, corresponding frequencies and guidelines for their use and selection is printed on page 23. For Australia, Channels 05 and 35 are reserved for Emergency Calls.

Programming the Instant Priority Channel

Turn the Channel Selector to select the Priority Channel you prefer.
Press and hold **[INST]** on the microphone for 2 seconds to store the new setting.

The  icon appears.

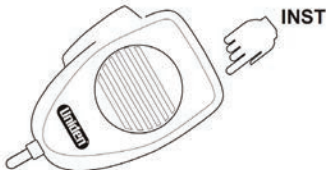

Operation

Recalling the Instant Channel

Momentarily press **[INST]** on the microphone at any time to return to the Instant Channel. Press **[INST]** again to return to the previous channel.

Transmitting

The UHF CB Radio uses UHF-CB Channels.



NOTE

For your reference a list of the available channels, corresponding frequencies and guidelines for their use and selection is printed on page 23. For Australia, Channels 05 and 35 are reserved for Emergency Calls.

Select the desired channel. Press the microphone's PTT button and speak normally into the microphone. Hold it approx. 7cm from your mouth. Release the **[PTT]** button to end the transmission and listen for a reply.

Call Function

Press **[CALL]** on the microphone. A three second ringing tone will be transmitted. You may select from 5 types of tones (see p.18 for "Selecting the Call tone").



NOTE

Current regulations require calling tones to be restricted to one transmission per minute. If a second transmission is attempted within one minute then an error tone will sound.

Using Repeater Channels

UHF CB Repeaters are used to retransmit or relay your signal. Repeaters will extend the range of your radio and overcome the shielding effect caused by solid obstructions. In normal Simplex operation, your radio transmits on one particular frequency and receives on that same frequency.

If there is a barrier that partially blocks your transmitted signal, the probability of another radio receiving the signal is very slim. Hills, tall buildings, metallic structures,...etc tend to act as a screen between radios.

Operation

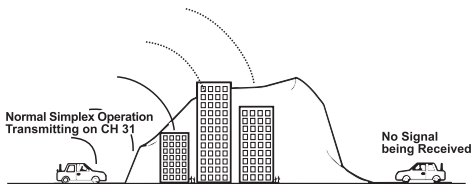

Standard Operation without the aid of a Repeater station.

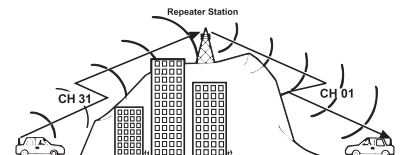

Operation with the aid of a Repeater Repeater Station (Duplex).

The signal coming from your radio is received by the Repeater Station and the re-transmitted at the same time on another channel. This operation is called "Duplexing".

For example,



CH01 on Duplex Mode will Receive on CH01 but Transmit on CH31
CH02 on Duplex Mode will Receive on CH02 but Transmit on CH32
etc...

If you transmit on CH01 Duplex mode, you are actually transmitting on CH31 the repeater station down-converts your signal and retransmits on CH01.



Operation

Operating the UHF CB Radio in Duplex Mode

For this example we are adopting CH01 as the channel being used in your area for repeater use.

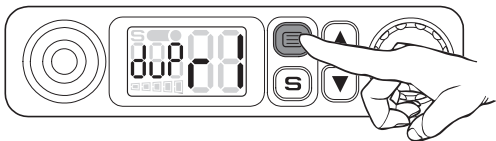
1. Press  2 times. The duplex setting flashes.
2. Turn the Channel Selector or press  /  to change the setting between simplex and duplex (“ r ” for repeater channels 01 - 08 or “ n ” for repeater channels 41 - 48).



3. Press  to store the setting.
4. Press and hold  to save & exit the menu mode. Only channels 01 - 08 and 41 - 48 are available for Duplex.



NOTE

Check with your local Retailer for information on available repeaters.

Scanning

The scan feature allows you to search for active channels automatically.

The UH5000 has two types of scanning; Open Scanning (OS) and Group Scanning (GS), to give you flexibility and allow you to use the radio more effectively.

1. Press  and Scanning starts. The **S** icon appears. The scan direction can be changed at any time by rotating the channel selector left or right.

Operation

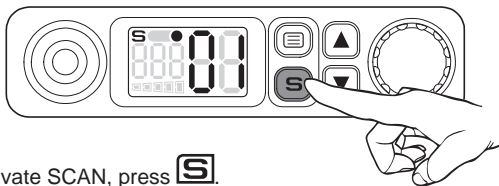

2. To deactivate SCAN, press .





Open Scan (OS) Mode

Allows continuous scanning of all selected channels. If an active channel is found, scanning will stop on that channel. If the received signal ceases, the unit will wait 3 seconds for the signal to return, otherwise scanning resumes. After transmission in scan mode, the unit will wait 20 seconds for the signal to return, otherwise scanning resumes. To skip the active channel, turn the Channel Selector.

Group Scan (GS) Mode & Priority Watch

Includes the accessory feature, Priority Watch, which allows you to monitor the Instant Priority Channel while scanning.

To use GS Mode Scanning;

1. Press  3 times. **Scn** shows and the oS/GS setting flashes.
2. Turn the Channel Selector or press  /  to change the setting to GS.
3. Press  to store the setting.
4. Press and hold  to save & exit the menu mode.



GS Scanning checks the Instant Priority Channel for activity every 1.5 seconds.

Operation

If the Priority Channel becomes active the radio will stay on that channel for as long as the signal is present. If the received signal ceases, Priority Scanning continues after 3 seconds. If scanning stops on a channel which is not a Priority Channel, the radio will continue monitoring the Priority Channel for activity while listening to the active one.



To deactivate SCAN, press the  button.

Add/Remove Channels from SCAN Memory

Select which Scanning Mode you wish to use; OS or GS.

Select the channel you want to store.



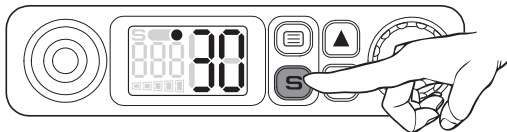

Press and hold  to store. The  icon appears and a short tone is

heard. To remove the channel from SCAN memory, press and hold  once more. The  icon disappears.



CTCSS (Continuous Tone Coded Squelch System) & DCS (Digital Coded Squelch)

Turn the Rotary Channel Selector to the desired channel to use CTCSS or DCS.



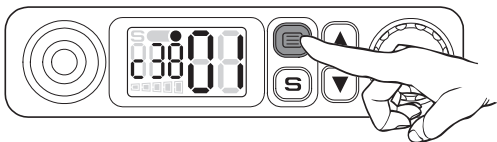

1. Press  1 time. CTCSS/DCS setting appears.
2. Turn the Channel Selector or press  /  to select the desired CTCSS code 01 - 38 or DCS code 01 - 104 (code 100 - 104 is represented by o0 - o4). To turn off CTCSS/DCS select the **oF** code.
3. Press  to store the setting.
4. Press & hold  to save & exit menu mode.
The CTCSS/DCS code displays for the selected channel.

Operation





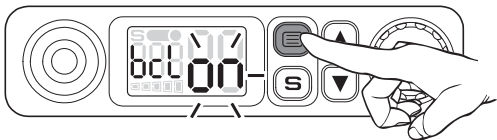

Busy Channel Lockout

If the channel is already in use, you can prevent the UHF CB Radio from transmitting. This is particularly important when using CTCSS/DCS.

1. Press  4 times. The BCL setting flashes.
2. Turn the Channel Selector or press  /  to change the setting between ON or OFF.
3. Press  to store the setting.
4. Press and hold  to save & exit menu mode.







Selecting the Call tone

1. Press  5 times. The call tone setting flashes.
2. Turn the Channel Selector or press  /  to change the setting between 1, 2, 3, 4 and 5.
3. Press  to store the setting.
4. Press and hold  to exit from the menu mode.







Operation

Roger Beep

1. Press  6 times. The roger beep setting flashes.
2. Turn the Channel Selector or press  /  to change the setting between ON or OFF.
3. Press  to store the setting.
4. Press and hold  to save & exit menu mode.







Beep On/Off

1. Press  7 times. The Beep setting flashes.
2. Turn the Channel Selector or press  /  to change the setting between ON or OFF.
3. Press  to store the setting.
4. Press and hold  to save & exit menu mode.







Backlight Colours

1. Press  8 times. The Backlight setting flashes.
2. Turn the Channel Selector or press  /  to change the setting between Blue, Red, Purple(magenta), Green, Cyan, Yellow and Clear (white).
3. Press  to store the setting.
4. Press and hold  to exit from the menu mode.

Operation







Backlight Brightness

1. Press  9 times. The Backlight Brightness setting flashes.
2. Turn the Channel Selector or press  /  to change the setting between Off (oF), 1(Lo), 2(mid) and 3(Hi).
3. Press  to store the setting.
4. Press and hold  to save & exit menu mode.



LCD Flip

1. Press  10 times. The Flip setting flashes.
2. Turn the Channel Selector or press  /  to change the flip orientation.
3. Press  to store the setting.
4. Press and hold  to save & exit menu mode.



CTCSS codes table

Code No.	Frequency (Hz)	Code No.	Frequency (Hz)
"oF"	OFF	20	131.8
1	67.0	21	136.5
2	71.9	22	141.3
3	74.4	23	146.2
4	77.0	24	151.4
5	79.7	25	156.7
6	82.5	26	162.2
7	85.4	27	167.9
8	88.5	28	173.8
9	91.5	29	179.9
10	94.8	30	186.2
11	97.4	31	192.8
12	100.0	32	203.5
13	103.5	33	210.7
14	107.2	34	218.1
15	110.9	35	225.7
16	114.8	36	223.6
17	118.8	37	241.8
18	123.0	38	250.3
19	127.3		

DCS codes table

Code No.	DCS Code (Octal)	Code No.	DCS Code (Octal)	Code No.	DCS Code (Octal)
1	023	36	223	71	445
2	025	37	225	72	446
3	026	38	226	73	452
4	031	39	243	74	454
5	032	40	244	75	455
6	036	41	245	76	462
7	043	42	246	77	464
8	047	43	251	78	465
9	051	44	252	79	466
10	053	45	255	80	503
11	054	46	261	81	506
12	065	47	263	82	516
13	071	48	265	83	523
14	072	49	266	84	526
15	073	50	271	85	532
16	074	51	274	86	546
17	114	52	306	87	565
18	115	53	311	88	606
19	116	54	315	89	612
20	122	55	325	90	624
21	125	56	331	91	627
22	131	57	332	92	631
23	132	58	343	93	632
24	134	59	346	94	654
25	143	60	351	95	662
26	145	61	356	96	664
27	152	62	364	97	703
28	155	63	365	98	712
29	156	64	371	99	723
30	162	65	411	100 (do0)	731
31	165	66	412	101 (do1)	732
32	172	67	413	102 (do2)	734
33	174	68	423	103 (do3)	743
34	205	69	431	104 (do4)	754
35	212	70	432		

UHF CB Channel Guidelines



NOTE

Always listen on a channel (or observe the receive signal level meter) to ensure it is not already being used before transmitting.

Channels 5 and 35 are used for emergency channels. CTCSS and DCS will not operate on these channels.

Please follow these guidelines for channel use in Australia:

- Channels 05 and 35 are Emergency Channels.
- Channel 11 is a Calling Channel.
- Channels 22 and 23 are for telemetry and telecommand applications, channels 61, 62 and 63 are for future use and TX is inhibited on these channels.

General communication is accepted on all other channels with these guidelines:

- Channel 40 - road channel (Australia).
- Channels 01-08 (and 31-38), and Channels 41-48 (and 71-78) are repeater channels.

Important information - 80 Channel UHF CB channel expansion

To provide all users additional channel capacity within the UHF CB Band. The ACMA will change the majority of the current wideband 40 channel use to narrowband channel use. This allows for additional channels to be added, up to 80 Channels.

This simply means that the new narrowband radio you have purchased will have more channels than older radios. Please refer to the guidelines above and the channel chart for further channel information.

A list of currently authorised channels can also be obtained from the ACMA website in Australia and the MED website in New Zealand.



NOTE

Interference / Poor Audio

When a new narrowband radio receives a signal from an older wideband radio the speech may sound loud - however the UH5000's built-in AVS (Automatic Volume Stabilizer) circuitry will detect and manage incoming audio to comparable levels.

Narrowband radios operating on CH41 - CH80 may encounter interference from a nearby wideband radios transmitting on high power on an adjacent channel (frequency).

When an older wideband radio receives a signal from a new narrowband radio the speech may sound quiet - the wideband radio user simply adjusts their radio volume for best performance.

The above situations are not a fault of the radio but a symptom of mixed wideband and narrowband radios in current use. It is expected that as older wideband radios are phased out this issue will be eliminated.

UHF CB Channels & Frequencies

CH No.	Simplex Mode Transmit / Receive Frequency (MHz)	Duplex Mode Transmit Frequency (MHz)	CH No.	Simplex Mode Transmit / Receive Frequency (MHz)
1	476.425	477.175 (CH31)	21	476.925
2	476.450	477.200 (CH32)	22	476.950 (RX only)
3	476.475	477.225 (CH33)	23	476.975 (RX only)
4	476.500	477.250 (CH34)	24	477.000
5	476.525	477.275 (CH35)	25	477.025
6	476.550	477.300 (CH36)	26	477.050
7	476.575	477.325 (CH37)	27	477.075
8	476.600	477.350 (CH38)	28	477.100
9	476.625		29	477.125
10	476.650		30	477.150
11	476.675		31	477.175
12	476.700		32	477.200
13	476.725		33	477.225
14	476.750		34	477.250
15	476.775		35	477.275
16	476.800		36	477.300
17	476.825		37	477.325
18	476.850		38	477.350
19	476.875		39	477.375
20	476.900		40	477.400

UHF CB Channels & Frequencies

CH No.	Simplex Mode Transmit / Receive Frequency (MHz)	Duplex Mode Transmit Frequency (MHz)	CH No.	Simplex Mode Transmit / Receive Frequency (MHz)
41	476.4375	477.1875 (CH 71)	61	future use 476.9375 (RX only)
42	476.4625	477.2125 (CH 72)	62	future use 476.9625 (RX only)
43	476.4875	477.2375 (CH 73)	63	future use 476.9875 (RX only)
44	476.5125	477.2625 (CH 74)	64	477.0125
45	476.5375	477.2875 (CH 75)	65	477.0375
46	476.5625	477.3125 (CH 76)	66	477.0625
47	476.5875	477.3375 (CH 77)	67	477.0875
48	476.6125	477.3625 (CH 78)	68	477.1125
49	476.6375		69	477.1375
50	476.6625		70	477.1625
51	476.6875		71	477.1875
52	476.7125		72	477.2125
53	476.7375		73	477.2375
54	476.7625		74	477.2625
55	476.7875		75	477.2875
56	476.8125		76	477.3125
57	476.8375		77	477.3375
58	476.8625		78	477.3625
59	476.8875		79	477.3875
60	476.9125		80	477.4125

Warranty

UNIDEN UH5000 UHF CB Transceiver

IMPORTANT: Satisfactory evidence of the original purchase is required for warranty service

Please refer to our Uniden website for any details or warranty durations offered in addition to those contained below.

Warrantor: The warrantor is Uniden Australia Pty Limited ABN 58 001 865 498 (“Uniden Aust”).

Terms of Warranty: Uniden Aust warrants to the original retail purchaser only that the UH5000 (“the Product”), will be free from defects in materials and craftsmanship for the duration of the warranty period, subject to the limitations and exclusions set out below.

Warranty period: This warranty to the original retail purchaser is only valid in the original country of purchase for a Product first purchased either in Australia or New Zealand.

Product	5 Years
Battery Pack & Accessories	1 Year

If a warranty claim is made, this warranty will not apply if the Product is found by Uniden to be:

- (A) Damaged or not maintained in a reasonable manner or as recommended in the relevant Uniden Owner’s Manual;
- (B) Modified, altered or used as part of any conversion kits, subassemblies or any configurations not sold by Uniden Aust;
- (C) Improperly installed contrary to instructions contained in the relevant Owner’s Manual
- (D) Repaired by someone other than an authorized Uniden Repair Agent in relation to a defect or malfunction covered by this warranty; or
- (E) Used in conjunction with any equipment, parts or a system not manufactured by Uniden.

Parts Covered: This warranty covers the Product and included accessories.

Warranty

User-generated Data: This warranty does not cover any claimed loss of or damage to user-generated data (including but without limitation phone numbers, addresses and images) that may be stored on your Product.

Statement of Remedy: If the Product is found not to conform to this warranty as stated above, the Warrantor, at its discretion, will either repair the defect or replace the Product without any charge for parts or service. This warranty does not include any reimbursement or payment of any consequential damages claimed to arise from a Product's failure to comply with the warranty.

Our goods come with guarantees that cannot be excluded under the Australian Consumer Law. You are entitled to a replacement or refund for a major failure and for compensation for any other reasonably foreseeable loss or damage. You are also entitled to have the goods repaired or replaced if the goods fail to be of acceptable quality and the failure does not amount to a major failure.

This warranty is in addition to and sits alongside your rights under either the COMPETITION AND CONSUMER ACT 2010 (Australia) or the CONSUMER GUARANTEES ACT (New Zealand) as the case may be, none of which can be excluded.

Procedure for obtaining warranty service: Depending on the country in which the Product was first purchased, if you believe that your Product does not conform with this warranty, you should deliver the Product, together with satisfactory evidence of your original purchase (such as a legible copy of the sales docket) to Uniden. Please refer to the Uniden website for address details. You should contact Uniden regarding any compensation that may be payable for your expenses incurred in making a warranty claim. Prior to delivery, we recommend that you make a backup copy of any phone numbers, images or other data stored on your Product, in case it is lost or damaged during warranty service.

UNIDEN AUSTRALIA PTY LTD

Phone: 1300 366 895

Email: custservice@uniden.com.au

THANK YOU FOR BUYING A UNIDEN PRODUCT.

Uniden[®]

© 2015 Uniden Australia Pty Limited. Printed in Vietnam.
: U01UT945HZZ(0)