

# Uniden®

## **UH5060** **Remote Speaker MIC** **UHF CB Transceiver**

---

For more exciting new products please visit our website:  
Australia: [www.uniden.com.au](http://www.uniden.com.au)

---

# OWNER'S MANUAL

# Contents

---

|  |           |
|--|-----------|
| <b>Introduction</b>                          | <b>3</b>  |
| <b>Controls &amp; Connectors</b>             | <b>4</b>  |
| <b>Indicators</b>                            | <b>6</b>  |
| <b>Included with your UH5060 Transceiver</b> | <b>7</b>  |
| <b>Connecting the Microphone</b>             | <b>8</b>  |
| <b>Mounting the MIC Hanger</b>               | <b>9</b>  |
| <b>Operation</b>                             | <b>12</b> |
| Turning on the Power                         | 12        |
| Setting the Auto Squelch                     | 13        |
| Monitor                                      | 14        |
| Selecting a Channel                          | 14        |
| Programming the Instant Priority Channel     | 15        |
| Recalling the Instant Channel                | 15        |
| Transmitting                                 | 15        |
| Call Function                                | 15        |
| DUAL Watch                                   | 16        |
| Using Repeater Channels                      | 16        |
| Operating the UHF CB Radio in Duplex Mode    | 17        |
| Scanning                                     | 18        |
| Open Scan (OS) Mode                          | 18        |
| Group Scan (GS) Mode                         | 19        |
| Priority Watch                               | 20        |
| Add/Remove Channels from SCAN Memory         | 20        |
| Selecting the Call tone                      | 21        |
| Busy Channel Lockout                         | 21        |
| Roger Beep                                   | 22        |
| CTCSS (Continuous Tone Coded Squelch System) | 22        |
| DCS (Digital Coded Squelch)                  | 23        |
| Beep On/Off                                  | 23        |
| Backlight                                    | 24        |
| LCD Contrast                                 | 24        |
| <b>CTCSS Codes Table</b>                     | <b>25</b> |
| <b>DCS Codes Table</b>                       | <b>26</b> |
| <b>UHF CB Channel Guidelines</b>             | <b>27</b> |
| <b>UHF CB Channels &amp; Frequencies</b>     | <b>28</b> |
| <b>Warranty</b>                              | <b>30</b> |

# Introduction

---

The Uniden UH5060 is designed to provide you with years of trouble free service. Its rugged components and materials are capable of withstanding harsh environments. Please read this Operating Manual carefully to ensure you gain the optimum performance of the unit.



NOTE

The citizen band radio service is licenced in Australia by ACMA Radio-communications (Citizen Band Radio Stations) Class Licence and in New Zealand by MED General User Licence for Citizen Band Radio and operation is subject to conditions contained in those licenses.

## Features



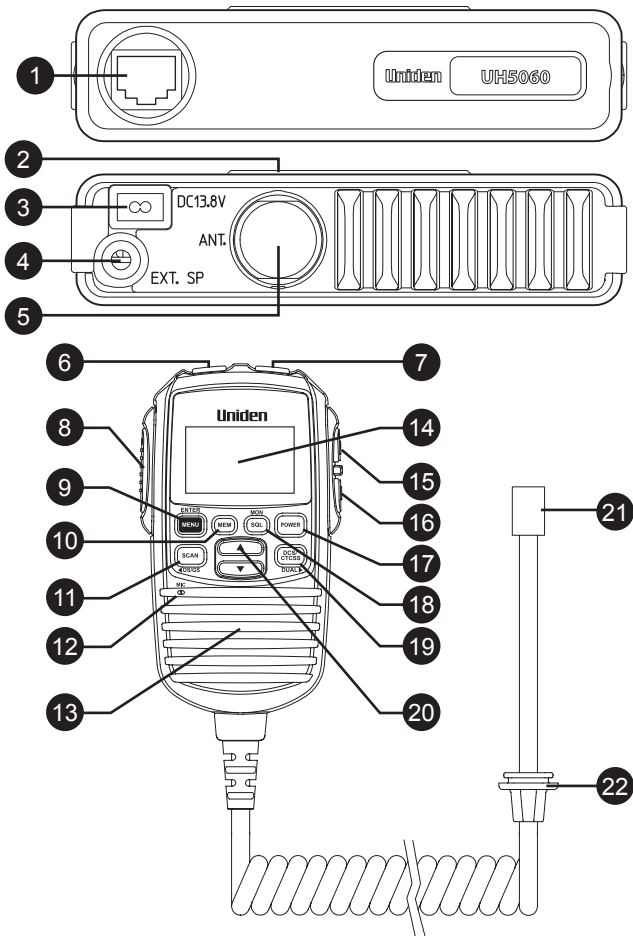

- Narrow Band (NB) 80 Channel Radio\*
  - Mini Compact Black Box
  - Remote LCD Speaker Microphone (Remote SPK/MIC) and Extension Cable
  - 12V DC Power Input
  - Built-in AVS Circuitry†
  - Transmission Power 5W
  - LCD Display with Backlight
  - LCD Backlight brightness control ("HI", "LO", "Off")
  - Signal Strength/ Power Meter
  - Instant Channel Programming
  - One touch Instant Channel recalling
  - Dual Watch with Instant Channel
  - Duplex Capability\*
  - Group Scan and Priority Channel Watch
  - Open Scan
  - Scan Channel Memory On/Off separately with Open Scan, Group Scan
  - Channel Select
  - Busy Channel Lock-out Function
  - Roger Beep Function On/Off
  - 5 Different Call Tones
  - 38 Built-in CTCSS (Continuous Tone Coded Squelch System) and 104 additional DCS (Digital Coded Squelch) codes that are user selectable
  - Volume Control
  - Base Speaker
  - External Speaker Jack
  - Power On/Off Push Switch
  - Front MIC Jack
  - Auto Squelch
  - Under and over voltage alert function
- \* Refer to p.27 - p.29 for channel information
- † AVS - Automatic Volume Stabilizer detects and manages incoming audio to comparable levels.

# Controls & Connectors



# Controls & Connectors

---

- 1 MIC Jack
- 2 Speaker
- 3 Power Input Connection (13.8VDC)
- 4 **EXT SP** - External Speaker Jack
- 5 UHF Antenna Connection
- 6 **CALL** - Call Tone Button
- 7 **INST** - Instant Channel Button
- 8 **PTT** - Push To Talk Button
- 9 **MENU/ENTER** - Menu and Select Button
- 10 **MEM** - Memory Scan Channel
- 11 **SCAN** - Scan Button  
OS/GS - Open Scan/Group Scan
- 12 MICROPHONE
- 13 SPEAKER
- 14 Liquid Crystal Display (LCD)
- 15 **VOL**  - Volume Up Button
- 16 **VOL**  - Volume Down Button
- 17 **POWER** - Power ON/OFF Button
- 18 **SQL** - Auto Squelch  
MON - Monitor Button
- 19 **DCS/CTCSS** - DCS & CTCSS Button  
DUAL - Dual Watch Button
- 20  /  - Select Up and Down Buttons
- 21 RJ45 type plug
- 22 Front MIC Jack Cover

# Indicators

---

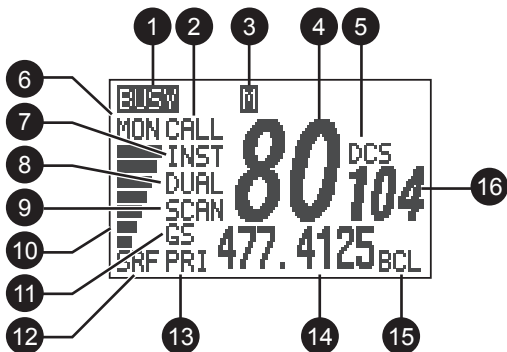

- |                                      |  |
|--------------------------------------|--|
| 1 <b>BUSY</b> - Channel Active       | 10 Signal Power Level                        |
| 2 <b>CALL</b> - Call Tone            | 11 <b>GS</b> - Group Scan                    |
| 3 <b>M</b> - Channel in Memory       | 12 <b>S/R F</b> - Receive Signal or Transmit |
| 4 Channel Number                     | 13 <b>PRI</b> - Priority Channel Watch       |
| 5 <b>DCS</b> - Digital Coded Squelch | 14 Channel Frequency                         |
| 6 <b>MON</b> - Monitor               | 15 <b>BCL</b> - Busy Channel Lockout         |
| 7 <b>INST</b> - Instant Channel      | 16 <b>DCS/CTCSS</b> Code Number              |
| 8 <b>DUAL</b> - Dual Watch           |  |
| 9 <b>SCAN</b> - Scan mode            |  |

# Included in your UH5060 Transceiver

---



Remote LCD Speaker  
Microphone  
(RM500)

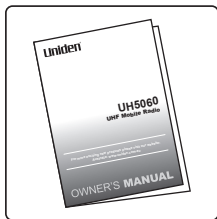

Owner's Manual

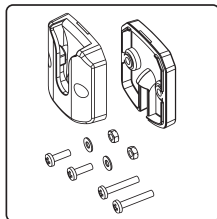

Microphone Hanger  
with screws, washers

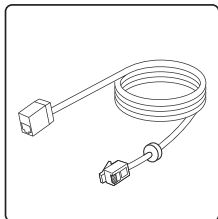

Extension Cable

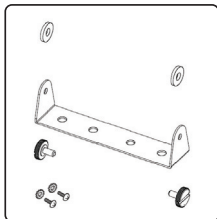

Mounting Bracket with  
mounting screws

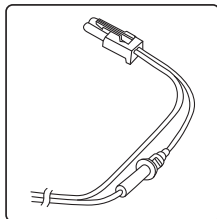

DC Power Cord  
with fuse

## Optional Accessories:

- UHF Antenna
- External Speaker

Visit the UH5060 page on the website for more information on the availability of optional accessories;

[www.uniden.com.au](http://www.uniden.com.au) for Australia

# Connecting the Microphone

---

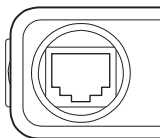

## MIC Jack

Before connecting the Microphone Jack decide if you need to use the Extension Cable - simply connect the MIC plug into the jack end of the Extension Cable

Push the MIC plug or Extension Cable plug into the MIC jack of the radio until the connection locks into place. Gently tug the MIC or Extension Cable cord to test that the connection is locked. Use the rubber cover which is on the cord to seal the MIC jack entry from dust.

## Disconnecting the MIC from the MIC Jack

Pull back the rubber cover and move it down along the cord. Using the flat blade of a screwdriver or similar object carefully push the lock tab of the MIC plug towards the MIC cord and at the same time tug on the MIC cord to draw back the MIC plug.



# Mounting the MIC Hanger

---

The Microphone Hanger comes in two parts. How and where you mount the MIC hanger will determine which parts to use.

## Conventional Mounting with Screws

Use the front part of the MIC Hanger only. Locate a suitable mounting position and mark and drill two 3mm holes. Fix the MIC Hanger into place with screws.

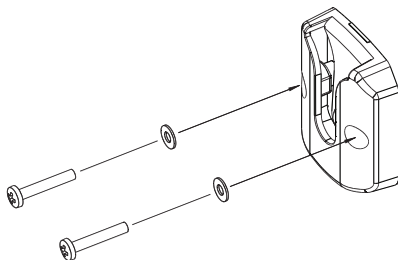

# Mounting the MIC Hanger

---

## Conventional Mounting with Double Sided Tape (not supplied)

High quality Double-Sided tape can be found at good retail stores. Secure the front and back pieces of the MIC Hanger using the supplied binding screws.

Locate a suitable mounting position.

Apply high quality Double-Sided tape onto the flat area of the MIC Hanger back piece and then press firmly to the mounting position.

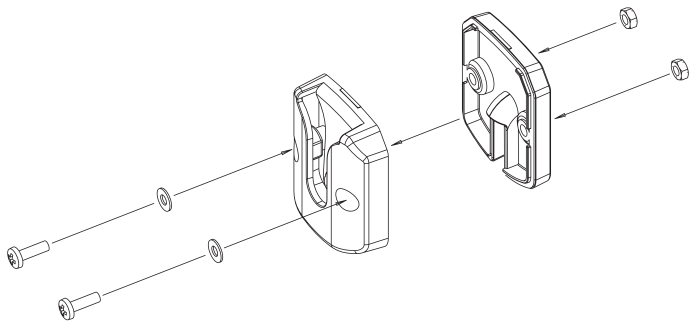

## MIC Hanger mounted over MIC Cable



NOTE

The curly cord of the Remote SPK/MIC can extend up to 1.5m. For practical installation of the MIC Hanger mounted over MIC Cable use this method with the Extension Cable.

# Mounting the MIC Hanger

---

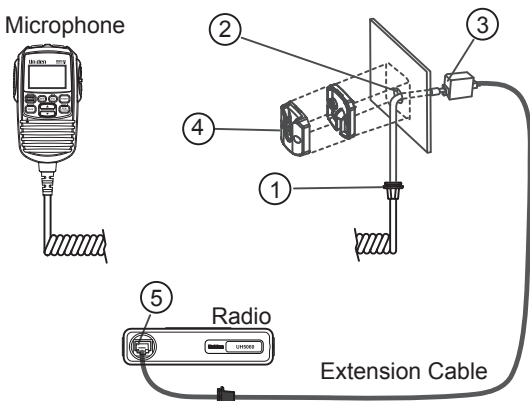

The plug of the extension cable connects to the Radio. The socket end of the extension cable connects with the microphone plug.

1. The rubber collar (dust cover) on the microphone cable is not required and can be cut away or pushed out of the way along the cable.
2. Drill a 13mm hole at the MIC hanger location.
3. Thread the microphone plug through the hole and connect with the extension cable.
4. Mount the MIC Hanger over the hole and cable.
5. At the Radio: Connect the extension cable plug to the MIC Jack. Fit the rubber bushing over the MIC jack.

# Operation

---

## Turning on the Power

Press and hold the **[POWER]** button.

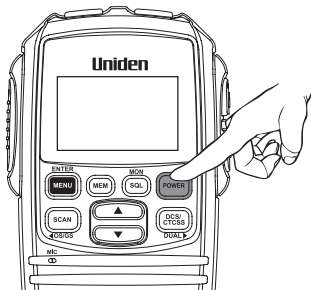

### Low-Voltage/High-Voltage Alert

If the power supply voltage exceeds 18VDC, an alert tone sounds and **HI DC** flashes for 5 seconds. The power source must not exceed 25VDC otherwise permanent damage may occur to your radio, which may not be covered by the manufacturer's warranty.



NOTE

If the input voltage falls below 10VDC, **LO DC** flashes for 5 seconds. The power turns off automatically if voltage falls below 8.5VDC.

Switch your UH5060 OFF and disconnect it from the power source, before locating the cause of the power supply problem.

# Operation

---

## Setting the Auto Squelch

The Auto Squelch feature has an Off setting and 3 preset squelch levels:

oFF - Squelch open



1 - max sensitivity (min squelch)

2 - med sensitivity (med squelch)

3 - min sensitivity (max/tight squelch)

It requires no adjustment.

1. Press **[SQL/MON]**. The squelch setting flashes.

2. Press  /  to change the setting.  
If tight squelch is selected SQT icon will also flash.

3. Press **[MENU/ENTER]** to store the setting.

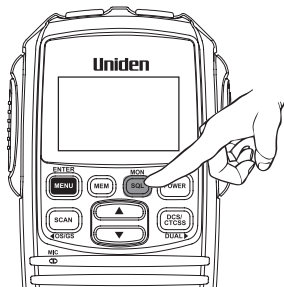

# Operation

## Monitor

Press and hold [SQL/MON] open the squelch and receive all weak signals. Press and hold [SQL/MON] to cancel.

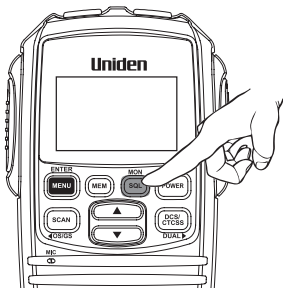

## Selecting a Channel

Press ▲ / ▼ to select the desired channel.

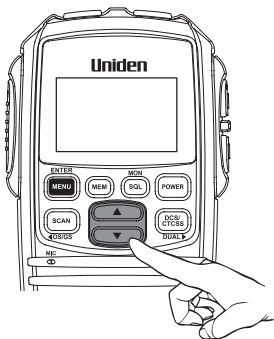



NOTE

For your reference a list of the available channels, corresponding frequencies and guidelines for their use is printed on p.27 - p.29. For Australia, Channels 05 and 35 are reserved for Emergency Calls.

# Operation

## Programming the Instant Priority Channel

Press  /  to select the Priority Channel you prefer. Press and hold **[INST]** button on the microphone for 2 seconds to store the new setting. INST icon appears.

## Recalling the Instant Channel

Momentarily press the **[INST]** button on the microphone at any time to return to the Instant Channel. Press **[INST]** again to return to the previous channel.

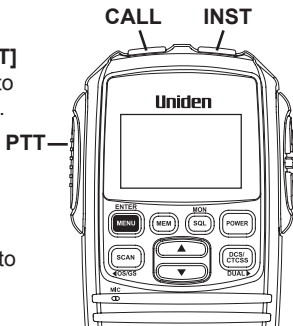

## Transmitting

The UHF CB Radio uses UHF-CB Channels.



NOTE

For your reference a list of the available channels, corresponding frequencies and guidelines for their use and selection is printed on p.27 - p.29. For Australia, Channels 05 and 35 are reserved for Emergency Calls.

Select the desired channel. Press the microphone's **[PTT]** button and speak normally into the microphone. Hold it approx. 7cm from your mouth. Release the **[PTT]** button to end the transmission and listen for a reply.

## Call Function

Press the microphone **[CALL]** Button. A three second ringing tone will be transmitted.

You may select from 5 types of tones (see p.21).



NOTE

Current regulations require calling tones to be restricted to one transmission per minute. If a second transmission is attempted within one minute then an error tone will sound.

# Operation

---

## DUAL Watch

Dual watch will continuously monitor the Instant channel no matter what other channel is on (see Programming the Instant Priority Channel above).

Press and hold **[DCS/CTCSS/DUAL]**. DUAL icon appears and a short tone beep is heard.

To cancel DUAL Watch press and hold **[DCS/CTCSS/DUAL]**. DUAL icon disappears.

## Using Repeater Channels

UHF CB repeaters are used to retransmit or relay your signal. Repeaters will extend the range of your radio and overcome the shielding effect caused by solid obstructions. In normal Simplex operation, your radio transmits on one particular frequency and receives on that same frequency.

If there is a barrier that partially blocks your transmitted signal, the probability of another radio receiving the signal is very slim. Hills, tall buildings, metallic structures,...etc tend to act as a screen between radios.

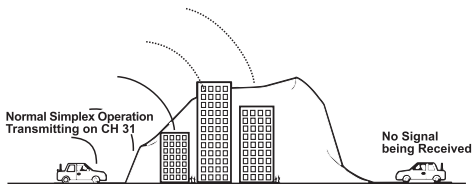

Standard Operation without the aid of a Repeater station.



# Operation

---

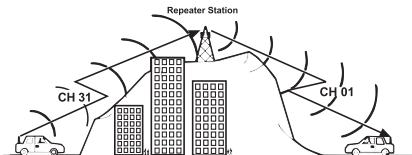

Operation with the aid of a Repeater Repeater Station (Duplex).

The signal coming from your radio is received by the Repeater Station and the re-transmitted at the same time on another channel. This operation is called “Duplexing”.

For example,

CH01 on Duplex Mode will Receive on CH01 but Transmit on CH31

CH02 on Duplex Mode will Receive on CH02 but Transmit on CH32  
etc...

**If you transmit on CH01 Duplex mode, you are actually transmitting on CH31 the repeater station down-converts your signal and retransmits on CH01.**

## Operating the UHF CB Radio in Duplex Mode

For this example we are adopting CH01 as the channel being used in your area for repeater use.

1. Press **[MENU/ENTER]**. The duplex setting flashes.
2. Press **▲** / **▼** to change the setting between ON (“ r ” for repeater channels 01 - 08 or “ n ” for repeater channels 41 - 48) or OFF (standard channel numbering).
3. Press **[MENU/ENTER]** to store the setting.

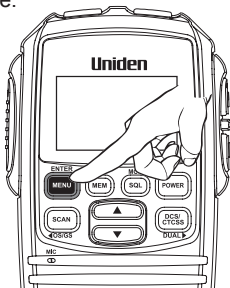

# Operation

---

4. Press and hold **[MENU/ENTER]** to save & exit from the menu mode. Only channels 01 - 08 and 41 - 48 are available for Duplex.



Check with your local Retailer for information on available repeaters.

## Scanning

The UHF CB Radio has a scanning feature that allows you to search for active channels automatically.

Furthermore, the UHF CB Radio is designed to have two types of scanning; Open Scanning (OS) and Group Scanning (GS), to give you flexibility and allow you to use the radio more effectively. Press **[SCAN/OS/GS]** and Scanning starts.

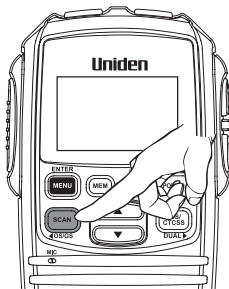

The SCAN icon appears.

The scan direction can be changed at any time by pressing  / .

## Open Scan (OS) Mode

Allows continuous scanning of all selected channels. If an active channel is found, scanning will stop on that channel. If the received signal ceases, the unit will wait 3 seconds for the signal to return, otherwise scanning resumes.

After transmission in scan mode, the unit will wait 20 seconds for the signal to return, otherwise scanning resumes.

To skip the active channel, press  /  momentarily. To deactivate SCAN, press **[SCAN/OS/GS]**.

# Operation



NOTE

If SCAN is deactivated while on an active channel, the UHF CB Radio will stay on that active channel. If no channels are active, the UHF CB Radio will reinstate the starting channel.



NOTE

OS Mode is indicated by the absence of the GS icon.

## Group Scan (GS) Mode

Includes the accessory feature Priority Watch which allows you to monitor the Instant Priority Channel while scanning (see p.15 for setting Instant Priority Channel and p.20 to turn on Priority Watch).

To use GS Mode Scanning, press and hold **[SCAN/OS/GS]**. GS icon appears on the display.

GS Scanning checks the Instant Priority Channel for activity regularly when Priority Watch is ON.

If the Priority Channel becomes active the radio will stay on that channel for as long as the signal is present. If the received signal ceases, Priority Scanning continues after 3 seconds.

If scanning stops on a channel which is not a Priority Channel, UHF CB Radio will continue monitoring the Priority Channel for activity while listening to the active one.

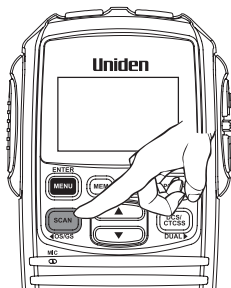

To deactivate SCAN, press the **[SCAN/OS/GS]** button.



# Operation

## Priority Watch

To switch Priority Watch On/Off;

1. Press **[MENU/ENTER]** two times.  
The Priority Watch setting flashes.
2. Press  /  on the Remote SPK/MIC to change the setting between ON or OFF.
3. Press **[MENU/ENTER]** to store the setting.
4. Press and hold **[MENU/ENTER]** to save & exit from the menu mode.

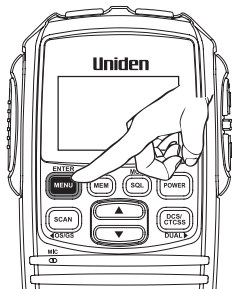

NOTE

If SCAN is deactivated while it is tuned to an active channel, the UHF CB Radio will stay on that active channel. If none of the channels are active, the UHF CB Radio will reinstate the scan start channel.



NOTE

If OS/GS Scanning is initiated when there are no channels programmed in OS/GS memory, an error tone will be heard and scanning will not start (see Programming Scan Channels - below).

## Add/Remove Channels from SCAN Memory

Select which Scanning Mode you wish to use - OS or GS. Select the channel you want to store.

Press to **[MEM]** store. MEM icon appears and a short tone beep is heard.

To remove the channel from SCAN memory, press **[MEM]** once more. The MEM icon disappears.

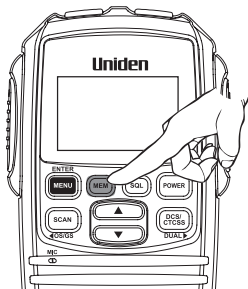

# Operation

## Selecting the Call tone

1. Press **[MENU/ENTER]** three times.  
The call tone setting flashes.
2. Press **▲** / **▼** to change the setting between 1, 2, 3, 4 and 5.
3. Press **[MENU/ENTER]** to store the setting.
4. Press and hold **[MENU/ENTER]** to save & exit from the menu mode.

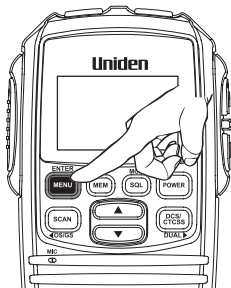

NOTE

If a button is not pressed within 10 seconds the UHF CB Radio will automatically exit the Menu Mode.

## Busy Channel Lockout

If the channel is already in use, you can prevent the UHF CB Radio from transmitting. This is particularly important when using CTCSS/DCS.

1. Press **[MENU/ENTER]** four times.  
The BCL setting flashes.
2. Press **▲** / **▼** to change the setting between ON or OFF.
3. Press **[MENU/ENTER]** to store the setting.
4. Press and hold **[MENU/ENTER]** to save & exit from the menu mode.

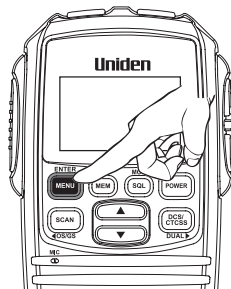

NOTE

If a button is not pressed within 10 seconds the UHF CB Radio will automatically exit the Menu Mode.

# Operation

## Roger Beep

1. Press **[MENU/ENTER]** five times.  
The roger beep setting flashes.
2. Press **▲** / **▼** to change the setting between ON or OFF.
3. Press **[MENU/ENTER]** to store the setting.
4. Press and hold **[MENU/ENTER]** to save & exit from the menu mode.

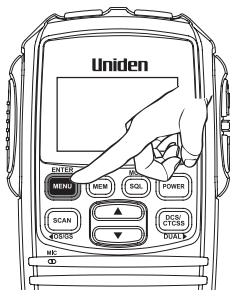

NOTE

If a button is not pressed within 10 seconds the UHF CB Radio will automatically exit the Menu Mode.

## CTCSS (Continuous Tone Coded Squelch System)

Press **▲** / **▼** the desired channel to use CTCSS.

Press **[DCS/CTCSS]**.

CTCSS icon flashes.

Press **▲** / **▼** on the Remote SPK/MIC to select the desired CTCSS code 01 - 38.  
Press **[DCS/CTCSS]** once to store the new setting.

To turn off CTCSS (or DCS) select the OFF code during setting.



# Operation

---



## DCS (Digital Coded Squelch)

DCS is a digital extension of CTCSS. It provides 104 extra, digitally coded, squelch codes that follow after the 38 CTCSS codes. CTCSS 1-38, followed by DCS 1-104.

Follow the steps for setting a CTCSS code. Press  /  until the DCS codes appear.

Press **[DCS/CTCSS]** to set. The DCS icon and code will display.

## Beep On/Off

1. Press **[MENU/ENTER]** six times.  
The Beep setting flashes.
2. Press  /  to change the setting between ON or OFF.
3. Press **[MENU/ENTER]** to store the setting.
4. Press and hold **[MENU/ENTER]** to save & exit from the menu mode.

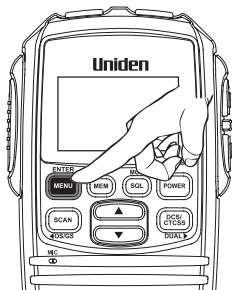

# Operation

---

## Backlight

1. Press **[MENU/ENTER]** seven times.  
The Backlight setting flashes.
2. Press **▲** / **▼** to change the setting between OFF, LO and HI.
3. Press **[MENU/ENTER]** to store the setting.
4. Press and hold **[MENU/ENTER]** to save & exit from the menu mode.

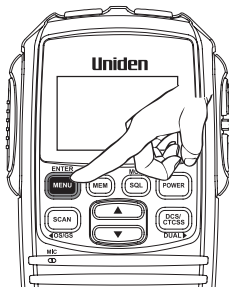

## LCD Contrast

1. Press **[MENU/ENTER]** eight times. The LCD Contrast setting flashes.
2. Press **▲** / **▼** to change the setting between 01 (low contrast) to 10 (high contrast).
3. Press **[MENU/ENTER]** to store the setting.
4. Press and hold **[MENU/ENTER]** to save & exit from the menu mode.

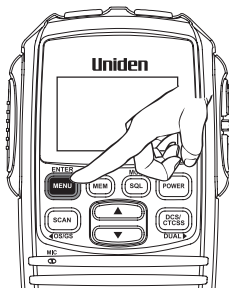



# CTCSS codes table

| Code No. | Frequency (Hz) | Code No. | Frequency (Hz) |
|----------|----------------|----------|----------------|
| "oF"     | OFF            | 20       | 131.8          |
| 1        | 67.0           | 21       | 136.5          |
| 2        | 71.9           | 22       | 141.3          |
| 3        | 74.4           | 23       | 146.2          |
| 4        | 77.0           | 24       | 151.4          |
| 5        | 79.7           | 25       | 156.7          |
| 6        | 82.5           | 26       | 162.2          |
| 7        | 85.4           | 27       | 167.9          |
| 8        | 88.5           | 28       | 173.8          |
| 9        | 91.5           | 29       | 179.9          |
| 10       | 94.8           | 30       | 186.2          |
| 11       | 97.4           | 31       | 192.8          |
| 12       | 100.0          | 32       | 203.5          |
| 13       | 103.5          | 33       | 210.7          |
| 14       | 107.2          | 34       | 218.1          |
| 15       | 110.9          | 35       | 225.7          |
| 16       | 114.8          | 36       | 223.6          |
| 17       | 118.8          | 37       | 241.8          |
| 18       | 123.0          | 38       | 250.3          |
| 19       | 127.3          |          |                |

# DCS codes table

| Code No. | DCS Code (Octal) | Code No. | DCS Code (Octal) | Code No. | DCS Code (Octal) |
|----------|------------------|----------|------------------|----------|------------------|
| 1        | 023              | 36       | 223              | 71       | 445              |
| 2        | 025              | 37       | 225              | 72       | 446              |
| 3        | 026              | 38       | 226              | 73       | 452              |
| 4        | 031              | 39       | 243              | 74       | 454              |
| 5        | 032              | 40       | 244              | 75       | 455              |
| 6        | 036              | 41       | 245              | 76       | 462              |
| 7        | 043              | 42       | 246              | 77       | 464              |
| 8        | 047              | 43       | 251              | 78       | 465              |
| 9        | 051              | 44       | 252              | 79       | 466              |
| 10       | 053              | 45       | 255              | 80       | 503              |
| 11       | 054              | 46       | 261              | 81       | 506              |
| 12       | 065              | 47       | 263              | 82       | 516              |
| 13       | 071              | 48       | 265              | 83       | 523              |
| 14       | 072              | 49       | 266              | 84       | 526              |
| 15       | 073              | 50       | 271              | 85       | 532              |
| 16       | 074              | 51       | 274              | 86       | 546              |
| 17       | 114              | 52       | 306              | 87       | 565              |
| 18       | 115              | 53       | 311              | 88       | 606              |
| 19       | 116              | 54       | 315              | 89       | 612              |
| 20       | 122              | 55       | 325              | 90       | 624              |
| 21       | 125              | 56       | 331              | 91       | 627              |
| 22       | 131              | 57       | 332              | 92       | 631              |
| 23       | 132              | 58       | 343              | 93       | 632              |
| 24       | 134              | 59       | 346              | 94       | 654              |
| 25       | 143              | 60       | 351              | 95       | 662              |
| 26       | 145              | 61       | 356              | 96       | 664              |
| 27       | 152              | 62       | 364              | 97       | 703              |
| 28       | 155              | 63       | 365              | 98       | 712              |
| 29       | 156              | 64       | 371              | 99       | 723              |
| 30       | 162              | 65       | 411              | 100      | 731              |
| 31       | 165              | 66       | 412              | 101      | 732              |
| 32       | 172              | 67       | 413              | 102      | 734              |
| 33       | 174              | 68       | 423              | 103      | 743              |
| 34       | 205              | 69       | 431              | 104      | 754              |
| 35       | 212              | 70       | 432              |          |                  |

# UHF CB Channel Guidelines

---

Always listen on a channel (or observe the receive signal level meter) to ensure it is not already being used before transmitting.

Channels 5 and 35 are used for emergency channels.

CTCSS and DCS will not operate on these channels.

Please follow these guidelines for channel use in Australia:

- Channels 05 and 35 are Emergency Channels.
- Channel 11 is a Calling Channel.
- Channels 22 and 23 are for telemetry and telecommand applications, channels 61, 62 and 63 are for future use and TX is inhibited on these channels.



NOTE

General communication is accepted on all other channels with these guidelines:

- Channel 40 - road channel (Australia).
- Channels 01-08 (and 31-38), and Channels 41-48 (and 71-78) are repeater channels.

## Important information - 80 Channel UHF CB channel expansion

To provide all users additional channel capacity within the UHF CB Band. The ACMA will change the majority of the current wideband 40 channel use to narrowband channel use. This allows for additional channels to be added, up to 80 Channels.

This simply means that the new narrowband radio you have purchased will have more channels than older radios. Please refer to the guidelines above and the channel chart for further channel information.

A list of currently authorised channels can also be obtained from the ACMA website in Australia and the MED website in New Zealand.



NOTE

## Interference / Poor Audio

When a new narrowband radio receives a signal from an older wideband radio the speech may sound loud - however the UH5060 built-in AVS (Automatic Volume Stabilizer) circuitry will detect and manage incoming audio to comparable levels.

Narrowband radios operating on CH41 - CH80 may encounter interference from a nearby wideband radios transmitting on high power on an adjacent channel (frequency).

When an older wideband radio receives a signal from a new narrowband radio the speech may sound quiet - the wideband radio user simply adjusts their radio volume for best performance.

The above situations are not a fault of the radio but a symptom of mixed wideband and narrowband radios in current use. It is expected that as older wideband radios are phased out this issue will be eliminated.

# UHF CB Channels & Frequencies

| CH No. | Simplex Mode Transmit / Receive Frequency (MHz) | Duplex Mode Transmit Frequency (MHz) | CH No. | Simplex Mode Transmit / Receive Frequency (MHz) |
|--------|---|--------------------------------------|--------|---|
| 1      | 476.425   | 477.175 (CH 31)                      | 21     | 476.925   |
| 2      | 476.450   | 477.200 (CH 32)                      | 22     | 476.950 (RX only)                               |
| 3      | 476.475   | 477.225 (CH 33)                      | 23     | 476.975 (RX only)                               |
| 4      | 476.500   | 477.250 (CH 34)                      | 24     | 477.000   |
| 5      | 476.525   | 477.275 (CH 35)                      | 25     | 477.025   |
| 6      | 476.550   | 477.300 (CH 36)                      | 26     | 477.050   |
| 7      | 476.575   | 477.325 (CH 37)                      | 27     | 477.075   |
| 8      | 476.600   | 477.350 (CH 38)                      | 28     | 477.100   |
| 9      | 476.625   |                                      | 29     | 477.125   |
| 10     | 476.650   |                                      | 30     | 477.150   |
| 11     | 476.675   |                                      | 31     | 477.175   |
| 12     | 476.700   |                                      | 32     | 477.200   |
| 13     | 476.725   |                                      | 33     | 477.225   |
| 14     | 476.750   |                                      | 34     | 477.250   |
| 15     | 476.775   |                                      | 35     | 477.275   |
| 16     | 476.800   |                                      | 36     | 477.300   |
| 17     | 476.825   |                                      | 37     | 477.325   |
| 18     | 476.850   |                                      | 38     | 477.350   |
| 19     | 476.875   |                                      | 39     | 477.375   |
| 20     | 476.900   |                                      | 40     | 477.400   |

# UHF CB Channels & Frequencies

| CH No. | Simplex Mode Transmit / Receive Frequency (MHz) | Duplex Mode Transmit Frequency (MHz) | CH No. | Simplex Mode Transmit / Receive Frequency (MHz) |
|--------|---|--------------------------------------|--------|---|
| 41     | 476.4375  | 477.1875 (CH 71)                     | 61     | future use<br>476.9375 (RX only)                |
| 42     | 476.4625  | 477.2125 (CH 72)                     | 62     | future use<br>476.9625 (RX only)                |
| 43     | 476.4875  | 477.2375 (CH 73)                     | 63     | future use<br>476.9875 (RX only)                |
| 44     | 476.5125  | 477.2625 (CH 74)                     | 64     | 477.0125  |
| 45     | 476.5375  | 477.2875 (CH 75)                     | 65     | 477.0375  |
| 46     | 476.5625  | 477.3125 (CH 76)                     | 66     | 477.0625  |
| 47     | 476.5875  | 477.3375 (CH 77)                     | 67     | 477.0875  |
| 48     | 476.6125  | 477.3625 (CH 78)                     | 68     | 477.1125  |
| 49     | 476.6375  |                                      | 69     | 477.1375  |
| 50     | 476.6625  |                                      | 70     | 477.1625  |
| 51     | 476.6875  |                                      | 71     | 477.1875  |
| 52     | 476.7125  |                                      | 72     | 477.2125  |
| 53     | 476.7375  |                                      | 73     | 477.2375  |
| 54     | 476.7625  |                                      | 74     | 477.2625  |
| 55     | 476.7875  |                                      | 75     | 477.2875  |
| 56     | 476.8125  |                                      | 76     | 477.3125  |
| 57     | 476.8375  |                                      | 77     | 477.3375  |
| 58     | 476.8625  |                                      | 78     | 477.3625  |
| 59     | 476.8875  |                                      | 79     | 477.3875  |
| 60     | 476.9125  |                                      | 80     | 477.4125  |

# Warranty

---

## UNIDEN UH5060 UHF CB Transceiver

**IMPORTANT: Satisfactory evidence of the original purchase is required for warranty service**

Please refer to our Uniden website for any details or warranty durations offered in addition to those contained below.

**Warrantor:** The warrantor is Uniden Australia Pty Limited ABN 58 001 865 498 (“Uniden Aust”).

**Terms of Warranty:** Uniden Aust warrants to the original retail purchaser only that the UH5060 (“the Product”), will be free from defects in materials and craftsmanship for the duration of the warranty period, subject to the limitations and exclusions set out below.

**Warranty period:** This warranty to the original retail purchaser is only valid in the original country of purchase for a Product first purchased either in Australia or New Zealand.

|                            |         |
|----------------------------|---------|
| Product                    | 5 Years |
| Battery Pack & Accessories | 1 Year  |

If a warranty claim is made, this warranty will not apply if the Product is found by Uniden to be:

- (A) Damaged or not maintained in a reasonable manner or as recommended in the relevant Uniden Owner’s Manual;
- (B) Modified, altered or used as part of any conversion kits, subassemblies or any configurations not sold by Uniden Aust;
- (C) Improperly installed contrary to instructions contained in the relevant Owner’s Manual
- (D) Repaired by someone other than an authorized Uniden Repair Agent in relation to a defect or malfunction covered by this warranty; or
- (E) Used in conjunction with any equipment, parts or a system not manufactured by Uniden.

**Parts Covered:** This warranty covers the Product and included accessories.

**User-generated Data:** This warranty does not cover any claimed loss of

# Warranty

---

or damage to user-generated data (including but without limitation phone numbers, addresses and images) that may be stored on your Product.

**Statement of Remedy:** If the Product is found not to conform to this warranty as stated above, the Warrantor, at its discretion, will either repair the defect or replace the Product without any charge for parts or service. This warranty does not include any reimbursement or payment of any consequential damages claimed to arise from a Product's failure to comply with the warranty.

Our goods come with guarantees that cannot be excluded under the Australian Consumer Law. You are entitled to a replacement or refund for a major failure and for compensation for any other reasonably foreseeable loss or damage. You are also entitled to have the goods repaired or replaced if the goods fail to be of acceptable quality and the failure does not amount to a major failure.

This warranty is in addition to and sits alongside your rights under either the COMPETITION AND CONSUMER ACT 2010 (Australia) or the CONSUMER GUARANTEES ACT (New Zealand) as the case may be, none of which can be excluded.

**Procedure for obtaining warranty service:** Depending on the country in which the Product was first purchased, if you believe that your Product does not conform with this warranty, you should deliver the Product, together with satisfactory evidence of your original purchase (such as a legible copy of the sales docket) to Uniden. Please refer to the Uniden website for address details. You should contact Uniden regarding any compensation that may be payable for your expenses incurred in making a warranty claim. Prior to delivery, we recommend that you make a backup copy of any phone numbers, images or other data stored on your Product, in case it is lost or damaged during warranty service.

## **UNIDEN AUSTRALIA PTY LTD**

Phone: 1300 366 895

Email: [custservice@uniden.com.au](mailto:custservice@uniden.com.au)

**THANK YOU FOR BUYING A UNIDEN PRODUCT.**

**Uniden<sup>®</sup>**

© 2015 Uniden Australia Pty Limited. Printed in Vietnam.  
U01UT946AZZ(0)