

Uniden®

XDECT 8355 Series

*For more exciting new products please visit our website:
Australia: www.uniden.com.au*

OWNER'S MANUAL

IMPORTANT SAFETY INSTRUCTIONS

When using your telephone equipment, basic safety precautions should always be followed to reduce the risk of fire, electric shock and injury to persons, including the following:

- **This unit is NOT waterproof.** DO NOT expose this unit to moisture.
- DO NOT expose this unit to rain.
- Do not use this product near water, for example, near a bath tub, wash bowl, kitchen sink or laundry tub, in a wet basement or near a swimming pool.
- Avoid using a telephone (other than a cordless type) during an electrical storm. There may be a remote risk of electric shock from lightning.
- Do not use the telephone to report a gas leak in the vicinity of the leak.
- Use only the power cord and batteries indicated in this manual. Do not dispose of batteries in a fire. They may explode. Check with local codes for possible special disposal instructions.
- Do not place the handset in any charging cradle without the battery installed and the battery cover securely in place.

SAVE THESE INSTRUCTIONS!

General Notices for New Zealand Model:

- The grant of a NZ Telepermit for any item of terminal equipment indicates only that Telecom has accepted that the item complies with minimum conditions for connection to its network. It indicates no endorsement of the product by Telecom, nor does it provide any sort of warranty. Above all, it provides no assurance that any item will work correctly in all respects with another item of Telepermitted equipment of a different make or model, nor does it imply that any product is compatible with all of Telecom's network services.
- The maximum volume setting of this telephone exceeds the Telecom specified volume requirement. Telecom takes no responsibility for the high volume available on this telephone, who believe this telephone is too loud should contact the manufacturer at the website indicated on owner's manual warranty page.
- For telephone networks other than Telecom there may be a charge incurred for local calls if the Insert 0 feature is on. Turn Insert 0 off.
- This equipment may not provide for the effective hand-over of a call to another device connected to the same line.

WHAT'S IN THE BOX?

XDECT 8355 base with cordless handset



Not Pictured:

- Rechargeable battery (BT-694 or BT-694s)
- AC adaptor (AAD-6135)
- Telephone cord
- Belt Clip
- Battery cover
- Wall Mount Bracket

You will also find:

Accessory handset and charger



Not Pictured:

- Repeater and AC Adaptor (Optional) (AAD-041S(R))
- Rechargeable battery (BT-694 or BT-694s)
- Charger AC adaptor (AAD-600S(R))
- Battery cover
- Belt Clip

If you purchased model number:	You should have:
XDECT 8355	None
XDECT 8355+1	1 of each
XDECT 8355+2	2 of each
XDECT 8355+3	3 of each

- If any item is missing or damaged, contact your place of purchase immediately. **Never use damaged products!**
- Need help? Get answers at our website: www.uniden.com.au for Australian model

CONTENTS

IMPORTANT SAFETY INSTRUCTIONS	2
INSTALLING YOUR PHONE	6
Charge the Battery.....	6
Connect the Telephone Cord	7
Mounting the base unit	8
Set Up the Repeater	10
SETTING UP THE MOBILELINK BLUETOOTH™ CONNECTION	14
GETTING TO KNOW YOUR PHONE	16
Parts of the Base	16
Parts of the Handset.....	19
Reading the Displays.....	21
USING THE MENUS	23
USING YOUR PHONE	27
Using Your Bluetooth Connection	28
Finding a Lost Handset	28
Changing the Volume	29
Staying in the Range.....	29
Using the Caller ID and Redial Lists	30
Using Call Waiting.....	32
Using Optional Headset.....	32
Using your Phonebooks.....	32
USING SPECIAL FEATURES	36
Power Failure Back Up System	36
DND (Do Not Disturb).....	37
Multihandset Features	38
Privacy Mode	39
Room Monitor	39
Call Transfer.....	39
Intercom	40
Voice Message Notification	40
USING THE ANSWERING SYSTEM	41
Answering System Options (Answering Setup).....	41
Personalize the Greeting	42
Accessing the Answering System	42
IMPORTANT INFORMATION	46
INDEX	52
ONE-YEAR LIMITED WARRANTY	53

FEATURES OF THE XDECT 8355 SERIES

- 1.8GHz Extended DECT Technology
- Bluetooth MobileLink
 - Connection for up to 4 Mobile phones
 - USB port to charge single Mobile phone
 - 6000 Phonebook download (up to 1500 entries per Mobile)
- Multi (12) Handset Capable¹ /DECT Headset capable
- Multi (2) Repeater Capable
- Wall Mountable Base
- Room Monitor
- 10 Speed Dial
- Power Failure Mode
- Digital Duplex Speakerphone on Handset
- 200 Number Home Phonebook
- Call Waiting²/Flash
- Call ID² Features
 - 50 Caller ID² Memories (shared)
 - Caller Name Tag² and Personal Ring²
 - Caller Announce on Base (Text-to-Speech for Caller ID Information)
- Call Block PRO²
- 10 Ringer options (4 Rings/6 Melodies)
- 4 Level Ringer Volume
- Ringer Do Not Disturb (DND) mode
- 6 Level Earpiece Volume
- 6 Level Speaker Volume
- Hearing Aid Compatible
- 10 Number Redial Memories
- 1-Line Conference Calling, up to 4 way (1 line (landline or mobile) + 2 Handsets + Base)
- 2-Line Conference Calling, up to 5 way (Landline Call + Mobile Call + 2 HS + Base)
- up to 10 Days Handset Standby Time³
- up to 10 Hours Handset Talk Time³
- Automatic ECO (power save) Mode
- Mute/Hold
- Headset Capable (for Handset)
- Shoulder Rest Beltclip
- Integrated Digital Answering Machine
 - 30 minutes recording capacity
 - up to 59 messages
 - Remote access from handset or away from home.

¹ Maximum expandable with XDECT 8305 accessory handsets.

² Caller ID, Call Waiting features work only if you subscribe to the service provided by your local telephone company. There is usually a fee for this service. Name Tag, Personal Ring and Call Block features require incoming Caller ID data.

³ Based on normal use with full battery charge.

Specifications subject to change. Visit the XDECT 8355 webpage on the Uniden website for the latest information.

INSTALLING YOUR PHONE

Charge the Battery

- 1) Unpack all handsets, battery packs, and battery covers. If any battery cover is already on the handset, press in on the notch and slide the cover down and off.
- 2) Line up the red and black wires on the battery pack with the label inside the handset.
- 3) Push the connector in until it clicks into place; tug gently on the wires to make sure the battery pack is securely connected.
- 4) Place the cover over the battery compartment and slide it up into place.
- 5) Connect the base AC adaptor to the **ADAPTOR** jack on the rear of the base.
- 6) If you have accessory handsets, connect a charger AC adaptor to each charger's **DC IN 9V** jack and set the plug into the notch as shown.
- 7) Plug the other end of each adaptor into a standard 240V AC power outlet.
- 8) Place a handset in the base and any accessory handset(s) in the charger(s) with the display(s) facing forward. The **CHARGE** light on the handset(s) should turn on.

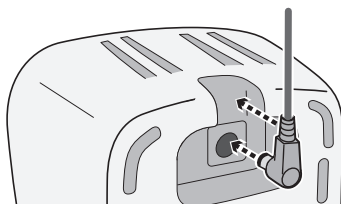
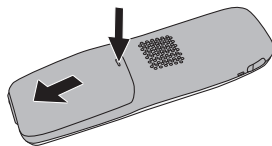

If...	Try...
the CHARGE light does not turn on	<ul style="list-style-type: none">• reseating the handset• checking the AC adaptor connection• seeing if the outlet is controlled by a wall switch

 **Charge all handsets completely (about 15-20 hours) before using them.**

Connect the Telephone Cord

Use the telephone cord to connect the **TEL LINE** jack to a standard telephone wall jack.

Test the Connection

- 1) Pick up the handset from the cradle and press **HOME/FLASH**. You should hear a dial tone, and the display should say *Talk*.

If...	Try...
you don't hear a dial tone or the display says <i>Check Tel Line</i>	checking the connection between the base and the phone jack.

- 2) Make a quick test call. (Press **END/CLEAR** to hang up.)

If...	Try...
there's a lot of noise or static	see page 46 for tips on avoiding interference.

- 3) Test any accessory handsets the same way. If you can't get a dial tone or the handset display says *Unavailable*, try moving the handset closer to the base or resetting it (see page 49). Charge all handsets completely (about 15-20 hours) before using them.

Installing the Belt Clip

Line up the holes on each side of the handset. To attach the belt clip, insert into the holes on each side of the handset. Press down until it clicks. To remove the belt clips, pull either side of the belt clip to release the tabs from the holes.

Mounting the base for desktop use

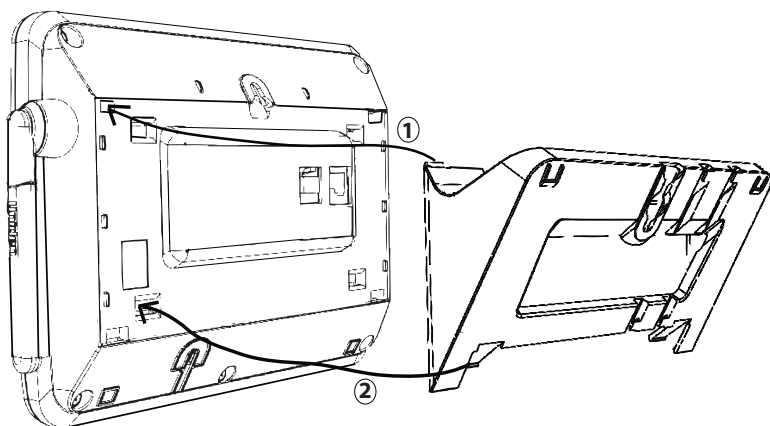

1. Turn the stand so the word **DESK** is right-side up (it will be on the left).
2. Insert the tabs into the notches at the top of the base.
3. Press in on the latches and slip them into the notches marked **DESK**.

Attach the base for wall mount

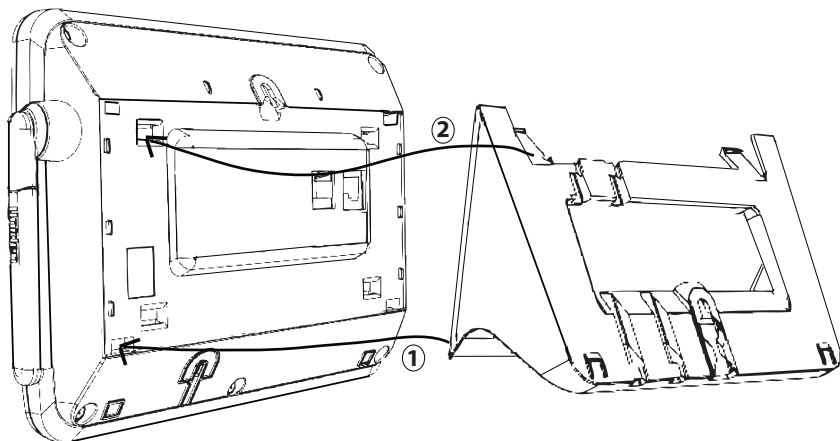

1. Turn the stand so the word **WALL** is right-side up (it will be on the left).
2. Insert the tabs into the notches at the bottom of the base.
3. Press in on the latches and slip them into the notches marked **WALL**.

Connect the Power and Telephone Cords

1. Connect the base AC adaptor to the power jack and the telephone cord to the **TEL LINE** jack. Route the cords as shown below:

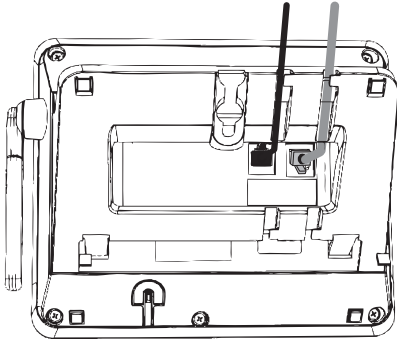

For Desktop Use

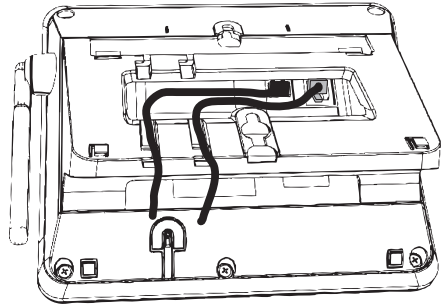

For Wallmount

2. Plug the AC adaptor into a standard 240V AC power outlet, and connect the telephone cord to a standard telephone wall jack.
3. If you are mounting the phone on the wall, place the mounting slots over the pins on the wall plate, and slide the base down to lock it into place.

Set Up the Repeater (Optional)

- The repeater is not a telephone; it must be registered to a phone base before using.
- Any repeater that came packaged with a base are already registered to that base for you.
- For instructions on registering repeaters to the base, see page 50.

How it Works

The repeater extends the range of your base in all directions, including up and down. Cordless handsets automatically connect to the repeater or the base, depending on which signal is stronger. You can roam anywhere within range of the base or the repeater(s) and make and receive calls as usual from your handsets.

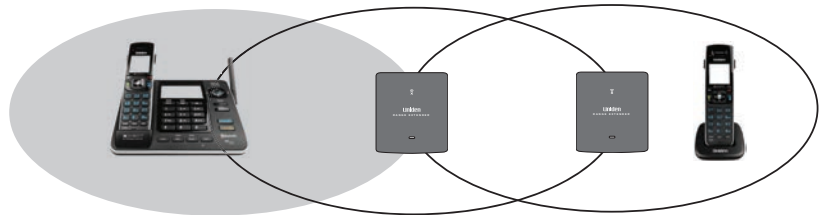
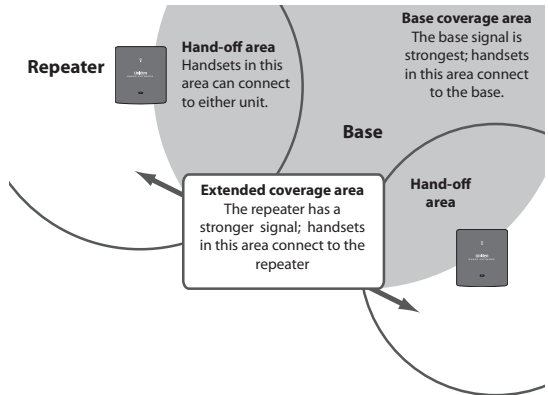

- Handsets operate exactly the same no matter which unit they connect to.
- Usually, you can't tell when a handset switches between the base and the repeater in the middle of a call.
- Your base supports a total of 2 repeaters, including any that were supplied with your phone.
- Repeaters can be up to 3 chain-links (maximum) from the base.

Connect the Repeater Power Cord

Use the included adaptor to connect the repeater to a regular indoor (240 V AC) power outlet.

Placing the Repeater

Here are a few tips for placing your repeater so that you get the clearest signal and the maximum range:

- Place the repeater just inside the base's coverage area, that is, as far from the base as possible where you still have good reception.
- Put the repeater at least 10 m away from the base or any other repeater.
- If you place the repeater on a flat surface, make sure the power cord doesn't pull on the unit and that people walking by won't knock it off the surface.
- If possible, mount the repeater on the wall.

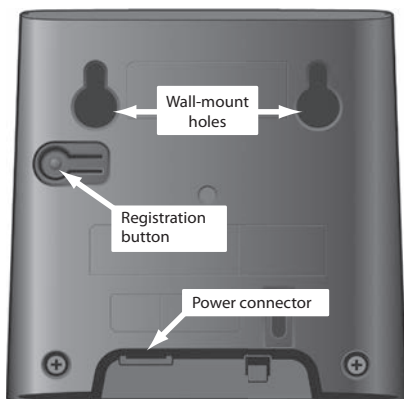

Finding the Base's Coverage Area

1. Stand near the base and make a call on a cordless handset that is registered to that base.
2. Continue the call and carry the handset away from the base. Make sure you go at least 10 meters.
3. Make a note where you start to hear noise on your call (the signal is getting weaker). You can use the signal strength icon on the handset display to find the best location: make a note where the icon indicates the signal is getting weaker.
4. Place the repeater anywhere inside the range where the handset had a clear connection with no noise and the icon showed a strong signal.

Testing the Location

Place the repeater in its final position and connect the AC adaptor. The **LINK** light will flash for a few seconds, then stay on.

If...	Try...
the Link light doesn't turn on	<ul style="list-style-type: none">• checking the repeater's AC adaptor• connecting the adapter to a different outlet.
the Link light continues flashing	<ul style="list-style-type: none">• making sure the repeater is not near electronic devices that can cause interference.• making sure there are no thick walls or large metal objects between the repeater and the base; these can block the signal.• making sure there is no other base or repeater within 10 m of this location.

Move further away from the base and make a test call on a cordless handset.

If...	Try...
the call won't connect	re-registering the repeater.
there is a lot of noise on the call	moving the repeater closer to the base.

Placing the Repeater on the Wall

You can mount the repeater directly to a wall using the horizontally aligned mounting slots at the back of the repeater unit. Before doing this consider the following:

- Avoid electrical cables, pipes, or other items behind the mounting location that could cause a hazard when inserting screws into the wall.
- Mount the repeater within distance of a working 240V AC power outlet.

⚠ The Repeater unit is NOT waterproof. If mounted onto an outside wall place under an eave or roof overhang where it is protected from direct weather conditions, DO NOT place in direct sunlight.

1. Insert two #10 screws into the wall, 57 mm apart. Leave the heads of the screws about 6 mm away from the wall. (For best results, use a level to ensure the screws are even.)

 **Remember to use appropriate anchors for the wall material.**

2. Keeping the AC adaptor cord out of the way, place the repeater over the screw heads and slide it down into place.

To remove the unit from the wall, just slide it up and lift it off the screw heads.

SETTING UP THE MOBILELINK BLUETOOTH™ CONNECTION

The XDECT 8355 with MobileLink technology can connect with mobile phones that support the Bluetooth V2.1 handsfree profile.

Visit our website on the front cover or contact customer service for a detailed list of tested mobile phones.

- If you are not certain of the profiles supported by your Bluetooth phone or if you have difficulty pairing your phone to the XDECT 8355, see the manual that came with your phone.
- With the MobileLink feature, you can essentially treat your mobile phone as a second line. You can use the XDECT 8355 handset to make and receive calls on your mobile phone number, put mobile phone calls on hold, and transfer calls to other handsets. See page 27 for more information.
- Bluetooth wireless devices have a maximum range of about 3 m; the actual range will vary depending on local conditions (obstacles, battery power, interference, etc.).

Pair your Bluetooth phone

Pairing “introduces” the Bluetooth device and the XDECT 8355 and gives them permission to connect to each other. In most cases, once you pair a phone to the XDECT 8355, these devices connect automatically whenever they detect each other. (If you have to manually reconnect each time, check the Bluetooth settings on your mobile phone.) You can pair your Bluetooth devices through the XDECT 8355.

1. Press **MENU/SELECT** to display the main menu.
2. Select the Bluetooth Setup menu, then select the Add Mobile phone submenu. The base goes into pairing mode when the handset displays Search & select from Mobile XDECT8355 PIN: 0000.
3. On your Bluetooth phone, start a search for other Bluetooth devices. (This process may take several seconds and it will be different for each mobile phone. See your phone owner’s manual for detailed instructions.)
4. Your phone should discover a device called XDECT 8355 or Handsfree device. When your phone asks if you want to pair with this device, answer yes.
5. If your phone prompts you for a PIN code or password to pair with the XDECT 8355, enter 0000 (four zeroes).

6. When your phone accepts the Bluetooth connection, the XDECT 8355 sounds a confirmation tone. The Bluetooth device number icon on the base and the handset display light up.

✗ **Most mobile phones automatically transfer the audio to a Bluetooth device as soon as it pairs; if yours does not, look in your mobile phone's Bluetooth setup for a "transfer audio" or "send audio to device" option.**

To Test the Connection

1. Pick up the handset from the cradle.
2. Dial the number you want to call, then press **MOBILE** on the handset. You may not hear a dial tone or ringing, but the handset display says *Talk*.
3. Make sure the call connects and you can hear clearly. (When you're finished, press **END/CLEAR** to hang up.)
4. The XDECT 8355 remembers the pairing information for your mobile phone; if it loses connection with your phone for any reason (e.g., the mobile phone travels out of range, runs out of charge, etc.), the XDECT 8355 can automatically reconnect the next time your phone becomes available.

Using the XDECT 8355 with four Bluetooth phones



- The XDECT 8355 can save the pairing information for four different Bluetooth phones, but it can only use one mobile line at any given time. For example, if you pair the XDECT 8355 to four Bluetooth phones, when you press **MOBILE** on the handset, the XDECT 8355 asks which phone you want to connect to.
- If you are using the XDECT 8355 to talk on one Bluetooth phone, the XDECT 8355 will not ring if a call comes in on another phone.
- To pair another Bluetooth phone, just repeat the pairing procedure with the new phone. (If the paired phones interfere when you're pairing the new one, just turn off Bluetooth on any paired phones until you finish pairing the new one.)



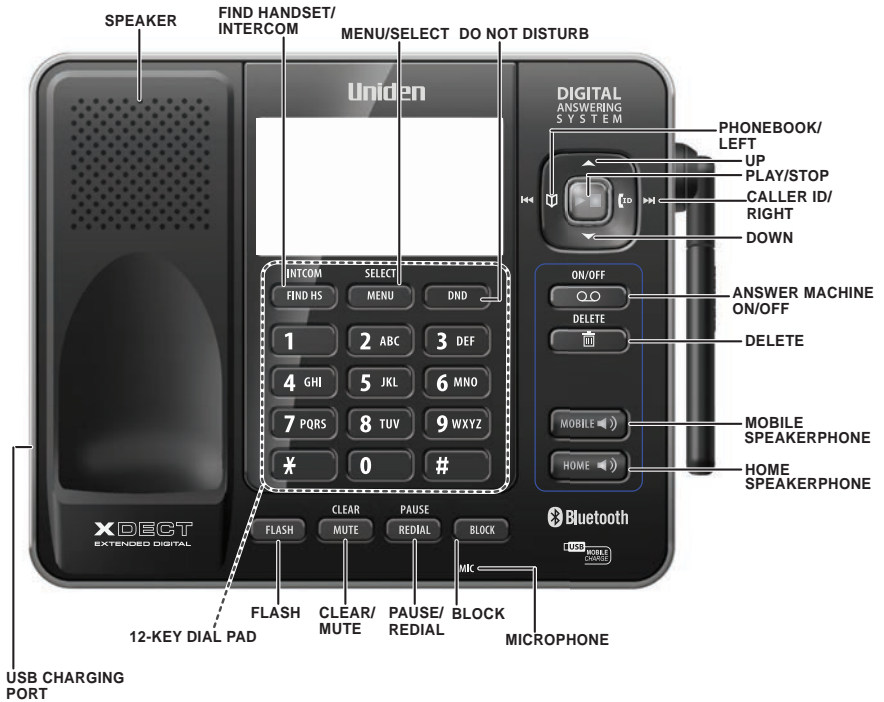

GETTING TO KNOW YOUR PHONE

Parts of the Base



Key (Icon)	What it does
FLASH	During a call: switch to a waiting call. In Australia: Press Flash and then 2 to make the switch.
MUTE/CLEAR	<ul style="list-style-type: none"> While this station is ringing: mute the ringer for this call only. During a call: mute the microphone. While entering text: delete one character, or press & hold to delete all the characters.
REDIAL/PAUSE	<ul style="list-style-type: none"> In standby: open the redial list. While entering a phone number: insert a 2-second pause.





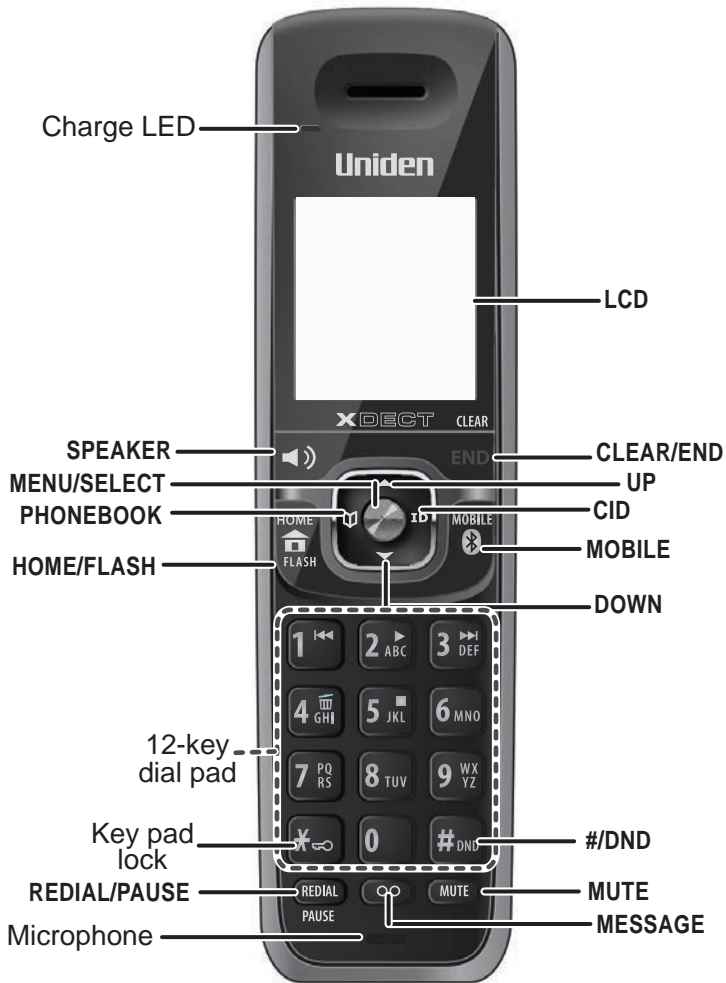

BLOCK	While the phone is ringing: add the incoming caller ID to the call block list (block the call).
FIND HANDSET/ INTERCOM	<ul style="list-style-type: none"> • In standby: page a handset using the intercom. • During a call: put the call on hold & start a call transfer.
MENU/SELECT	<ul style="list-style-type: none"> • In standby: open the menu. • In the menu or any list: select the highlighted item.
DO NOT DISTURB	In standby, press and hold to turn the Do Not Disturb feature on or off (see page 37).
PLAY/STOP ►■	<ul style="list-style-type: none"> • In standby: start playing messages. • While a message is playing: stop playing messages. • In the menu or a list: exit the menu completely.
PHONEBOOK/ LEFT 	<ul style="list-style-type: none"> • In standby or during a call: open the phonebook. • In any menu or list: go up one level. (If you are already at the top level, the phone exits the menu and returns to the previous operation.) • During text entry: move the cursor to the left. • While playing messages: for the first 2 seconds, go to the previous message; after that: go to the start of this message.
CALLER ID/RIGHT 	<ul style="list-style-type: none"> • In standby or during a call: open the Caller ID list. • During text entry: move the cursor to the right. • While a message is playing: skip to the next message.
UP (▲)	<ul style="list-style-type: none"> • In standby: increase the ringer volume. • During a speakerphone call or while a message is playing: increase the speaker volume. • In the menu or any list: move the cursor up one line.
DOWN (▼)	<ul style="list-style-type: none"> • In standby: decrease the ringer volume. • During a speakerphone call or while a message is playing: decrease the speaker volume. • In the menu or any list: move the cursor down one line.

ON/OFF 	In standby: turn the answering system on or off.
DELETE 	<ul style="list-style-type: none"> • While a message is playing: delete this message. • In standby: delete all messages.
MOBILE  SPEAKERPHONE	<ul style="list-style-type: none"> • In standby: start a speakerphone call using a paired Bluetooth phone. • While a paired phone is ringing: answer the incoming call. • During a MobileLink call: hang up.
HOME  SPEAKERPHONE	<ul style="list-style-type: none"> • In standby: start a speakerphone call (get a dial tone). • During a speakerphone call: hang up.
USB Charging Port	Standard size USB port for charging devices.

Parts of the Handset



LED Status	Description
Steady On	On Standby and Charging
Slow Blink	New message received on the answering machine/ voicemail
Fast Blink	Receiving calls

Key Icon	What it does
SPEAKER 	Switch a normal call to the speakerphone (and back).
END/CLEAR	<ul style="list-style-type: none"> • During a call: hang up. • In the menu or any list: go to previous menu. • When entering text or numbers: erase the character at the cursor.
HOME/FLASH 	<ul style="list-style-type: none"> • In standby: start a telephone call on your land line (get a dial tone). • During a call: switch to a waiting call. In Australia: Press Home/Flash and then 2 to make the switch.
MOBILE 	<ul style="list-style-type: none"> • In standby: start a telephone call using a paired Bluetooth phone. • While a paired phone is ringing: answer the incoming call. • During a MobileLink call: switch to a waiting call.
MENU/SELECT	<ul style="list-style-type: none"> • In standby: open the menu. • In the menu or any list: select the highlighted item.
PHONEBOOK 	<ul style="list-style-type: none"> • In standby or during a call: open the phonebook. • In the menu: go back to the previous screen. • When entering text: move the cursor to the left.
CID	<ul style="list-style-type: none"> • In standby: or during a call: open the Caller ID list. • When entering text: move the cursor to the right.
UP 	<ul style="list-style-type: none"> • In standby: increase the ringer volume. • During a call: increase the audio volume. • In any menu or list: move the cursor up one line.
DOWN 	<ul style="list-style-type: none"> • In standby: decrease the ringer volume. • During a call: decrease the audio volume. • In any menu or list: move the cursor down one line.
MUTE 	<ul style="list-style-type: none"> • During a call: mute the microphone. • While the phone is ringing: ignore this call (mute the ringer).
	<ul style="list-style-type: none"> • In standby: access your answering machine.
REDIAL/PAUSE	<ul style="list-style-type: none"> • In standby: open the redial list. • When entering a phone number: insert a 3-second pause.
#/DND	Press and hold to silence the ringers on the base and all handsets for a specific period of time.
* 5	Press and hold to lock/unlock the keypad.

Reading the Displays



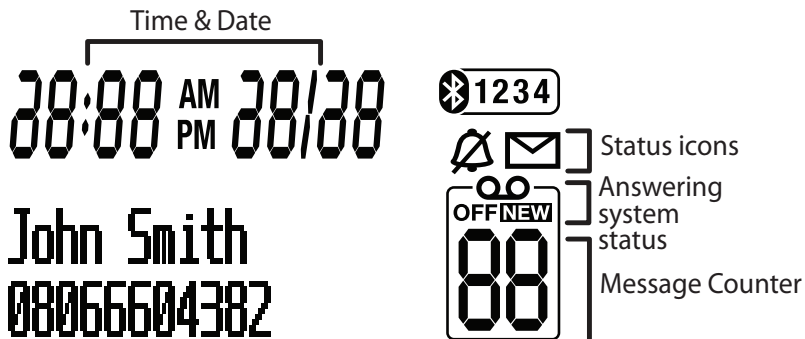



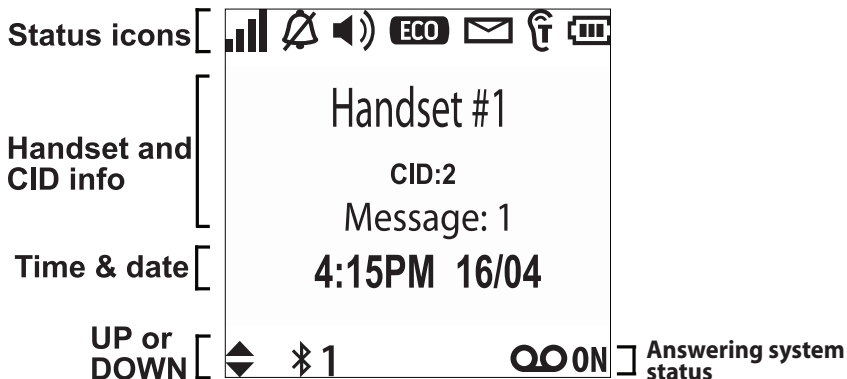



On the Base



On the Handset



The table shows the possible status icons and what they mean. Since the icons appear based on what the phone is doing, you won't see all the icons at the same time.

Icon	What it means
	The signal from the base is 1) weak through 4) strong.
	The ringer is turned off and will not ring for new calls.
OFF  ON	Answer Machine ON/OFF status.
	The handset is using ECO (power save) mode.
	The speakerphone is on.
	You have a voice message waiting.
	T-coil mode is on (see page 24).
	Privacy Mode is on: no other handset can join the call.
	The battery levels; Level 3 (Full) Level 2 Level 1 Level 0 (Empty)
 1 2 3 4	Bluetooth device number linked to the XDECT 8355.
	Home phone line.
[Aa] - [aA]	Enter 1) capital or 2) lower case letter (see page 26). Appears when you are entering text.

USING THE MENUS

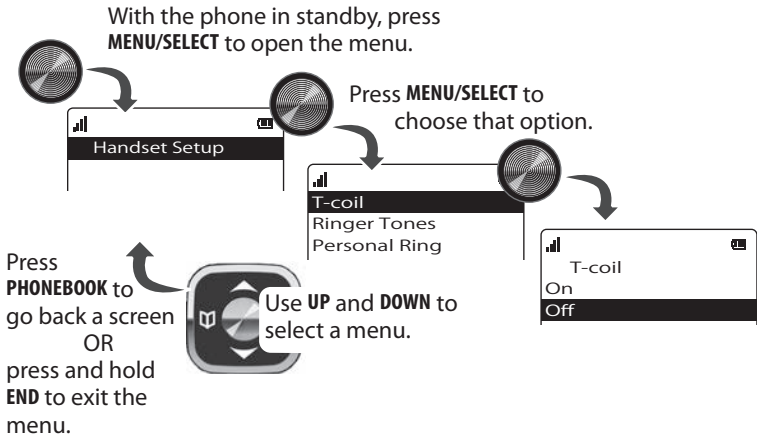

If you don't press any keys for about 30 seconds, the handset exits the menu. During a call, use **PHONEBOOK** to back out of the menu without hanging up.

Intercom Menu

The Intercom menu lets you connect 2 handsets without using the phone line. Any handset can connect to an intercom call, but only two handsets can be in the call at one time.

Base Setup Menu

This menu is available on the base only.

Menu Option	What it does
Key Touch Tone	Have a keypad sound a tone when you press a key.
LCD Contrast	Change the contrast of the display.
Caller Announce	Turn Text-to-Speech on or off to hear CID information.

Bluetooth Setup Menu

Use the Bluetooth Setup menu to pair to a mobile phone to the XDECT 8355 and select a mobile phone, if you pair more than one.

When you select the Bluetooth Setup Menu, *Add Mobile* displays. Select this option to pair your mobile phone with the XDECT 8355.

Then select the paired mobile to get the options displayed below.

Menu Option	What it does
Make Call	Use this option to make a call through the mobile using the Handset or Base.
Privacy Setup	Determines which handsets will ring when a mobile call comes in (default = off).
Download PB	Downloads the mobile phonebook to the base.
Remove Mobile	Un-pairs a mobile phone from the base.

Handset Setup Menu

You can change these settings separately for each handset.

Menu Option	What it does
<i>T-coil</i>	Turn on T-coil mode to reduce noise on hearing aids equipped with a telecoil (T-coil) feature. T-coil mode shortens talk time, so keep your battery fully charged.
<i>Ringer Tones</i>	Choose this handset's ring tone for landline and paired mobile line. As you highlight each ring tone, the phone plays a sample. When you hear the tone you want, press MENU/SELECT .
<i>Personal Ring</i>	Turn on personal ring so you can assign a special ring tone to people in your phonebook. With Caller ID, this HS uses the assigned tone when the person calls.
<i>Auto Talk</i>	Have this handset answer a call when you pick it up from the cradle (without pressing any buttons).
<i>Any Key Answer</i>	Have this handset answer a call when you press any key on the 12-key dialpad.
<i>Banner</i>	Change the name used on the handset's display.
<i>Key Touch Tone</i>	Have the keypad sound a tone when you press a key.
<i>LCD Contrast</i>	Change the contrast of the display
<i>HD Audio</i>	Turn HD Audio on or off.

Date & Time Menu

Use this menu to set the clock. Enter the date (DD/MM/YY) and time, select *AM* or *PM*. Use **CID** to move the cursor past a digit without changing it. If you have CID service, you can set it to provide the time (*Global Setup/Time Adjustment*).

Global Setup Menu

The settings on this menu affect all handsets. Only one handset at a time can change these menu options.

Set Line Mode	Do not change this setting unless instructed to by customer service.
VMWI Reset	Reset the Voice Message Waiting Indicator (see page 40).
Edit Voice Mail	Enter, edit your voice mail access number (page 40)
Edit Int'l No	Enter, edit, or delete international numbers. The “+” in a phonebook entry will be actually dialed with this number.
Insert 0	This feature adds “0” or “00” at the beginning of the number received from Caller ID. The default setting for New Zealand is ON. The default setting for Australia is OFF.
Time Adjustment	Select <i>Auto from CID</i> to allow phone network to automatically set cordless phone system time (Caller ID service required).

Call Blocking Menu

With the Call Block PRO feature, you can register individual contact numbers or even certain digits, to block calls from those numbers. For example, if you register “02 9597 9” then all calls from contact numbers beginning with “02 9597 9” will be blocked. If you register “02 9597 9xxx” then all calls from that particular contact number will be blocked.

1. In standby, press **MENU/SELECT** and scroll down to select the option Call Blocking.
The following four options are displayed; View Number, Create New, Private Number and Unknown Number.
2. Select the option, Create New. You will be given the option to enter a name, press **MENU/SELECT** after you have finished doing so.

3. Next, enter the desired number (along with the area code, where necessary) and press **MENU/SELECT** to save.

Under the Call Blocking menu, use the following options:

View Number to view all the numbers that have been blocked.

Private Number, to block all calls from private numbers.

Unknown Number, to block all calls from unknown numbers.

Room Monitor Menu

This feature allows you to monitor sounds in another room. Place a handset in the room you wish to monitor; it will function as a microphone. A second handset/base can be used as a remote speaker, allowing you to monitor sounds in the room.

To enter Room Monitor mode, press **MENU/SELECT**. Then select the Room Monitor. Select the handset/base you want to monitor. Press **END/CLEAR** on the handset or **PLAY/STOP** on the base when you want to stop monitoring.

Entering Text on Your Phone

Use the 12-key dial pad anytime you want to enter text into your phone (a name in the phonebook, the handset banner, etc.). If two letters in a row use the same key, enter the first letter; wait for the cursor to move to the next space and enter the second letter.

To...	Press...
move the cursor left	PHONEBOOK
move the cursor right	CID
erase the character at the cursor	END/CLEAR
enter a blank space	#.
switch between upper and lower case letters	*
rotate through the punctuation and symbols	0.

USING YOUR PHONE

This section explains the most common functions on the phone.

To...	From the Landline...	From the Mobile...
make a call, dial the number, then	Press HOME/FLASH or SPEAKER .	Press MOBILE . If two or more mobile phone is paired, the phone prompts you to choose one.
answer a call	Press HOME/FLASH or SPEAKER .	Press MOBILE .
hang up	Press END/CLEAR or place the handset in the cradle.	
ignore the call (mute the ringer)	Press MUTE while the phone is ringing.	
switch to/from the speaker	Press SPEAKER .	
switch from one line to the other (automatic hold)	Press MOBILE . If two or more mobile phone is paired, the phone prompts you to choose one.	Press HOME/FLASH
mute the microphone	Press MUTE .	
	Press again to turn the microphone back on.	
put a call on hold	Press MENU/SELECT and select <i>Hold Transfer</i> (after 2 min 50 secs on hold the call will be disconnected).	
return to a call on hold	Press HOME/FLASH .	Press MOBILE .

Using Your Bluetooth Connection

After you have paired your mobile phone with the XDECT 8355 (see page 14), you can make and receive calls from your mobile phone through the XDECT 8355.

To use the *Bluetooth* menu options, press **MOBILE** with the phone in standby, then select a mobile phone. Select one of these options:

To...	Select...
make a mobile phone call	<i>Make Call</i> ; enter the number to call.
let the specific handsets ring for incoming calls on that mobile phone	<i>Privacy Setup</i> , then select <i>On</i> or <i>Off</i> . All handsets and base set to <i>Off</i> : All handsets and base will ring (default). One or more handsets or base set to <i>On</i> : Only handsets or base set to <i>On</i> will ring. Other handsets or base do not ring but they can still receive calls and get CID information.
download phonebook	<i>Download PB</i> . The phone displays a confirmation screen when complete.
delete Bluetooth pairing	<i>Remove Mobile</i> . The phone displays a confirmation screen when complete.

Finding a Lost Handset

With the phone in standby, press **FIND** on the base and select ALL. All handsets beep for 1 minute; to cancel, press **FIND** again or press any handset key. You can also opt to FIND only specific handset.

Changing the Volume

To change the...	When...	Press...
earpiece volume for each handset	you are listening to that earpiece or speaker (playing messages, etc.)	UP to increase the volume. DOWN to decrease it.
speaker volume		
ringer volume (If you turn the ringer all the way down, that particular ringer turns off.)	The phone is in standby.	

Staying in the Range

Your system will alert you when you are out of range (or about to go out of range).

If...	Then...
the handset and base are connected and no signal from the base	the handset sounds an error tone and <i>Out of Range</i> or <i>Unavailable at this time</i> displays.
the handset is in Talk mode and moves out of range	the outside line is put on Hold for 30 seconds and then dropped. The LCD alternately displays <i>Out of Range</i> and <i>Check Base Power</i> .
the handset and base are in standby mode and the handset does not get a signal from the base	the LCD alternately displays <i>Out of Range</i> and <i>Check Base Power</i> .
audio deteriorates	the handset sounds an error tone. The LCD alternately displays <i>End of Range</i> and <i>Move toward base</i> .
you are trying to go off-hook	call data displays and then an error tone sounds. The LCD alternately displays <i>Unavailable at this time</i> .
you are trying to go on-hook	<i>END</i> displays.

Using the Caller ID and Redial Lists

Caller ID (CID) is a service available from your telephone provider that shows the phone number (and sometimes the caller's name) of incoming calls. Contact your telephone provider for more information.

Caller ID List	Redial List
<ul style="list-style-type: none"> • The phone saves the information for the last 50 incoming calls (both land line and mobile phone calls) to the <i>CID list</i>. An asterisk (*) marks any calls received since the last time you checked the record details. • All handsets and base share the same CID list. • In standby, handsets and base show how many calls came in since the last time you checked the CID list. 	<ul style="list-style-type: none"> • Each handset and base remembers the last 10 numbers you dialed on it. • Only one handset or base can access its redial list at a time. • The handset does not record which line was used to call the number.

To..	Press...
open the CID list	CID , then use the UP and DOWN keys to enter the list. Up to 5 entries display at a time.
open the redial list	REDIAL/PAUSE
scroll through the lists	UP to select the previous number. DOWN to select the next number. In CID list: RIGHT to show details LEFT to return to the previous screen.
select the CID number	MENU/SELECT to view the CID data of the highlighted number.
dial this number from the land line	(First, make sure the number is selected, see above). HOME/FLASH or SPEAKER .

dial this number from the mobile phone	MOBILE. If you have two or more mobile phones paired, select the phone you want and press MENU/SELECT.
close the lists	END/CLEAR.

For individual record options, find a number (and review the detail for a CID record), and then press **MENU/SELECT** to display the following options:

Menu Option	What it does...
<i>Delete Entry</i>	Erase the number from the list.
<i>Store Into PB</i>	Add the number to the phonebook. The phone displays the <i>Edit Name</i> screen (see page 33).
<i>Add Call Block</i>	Add the number to the Call Blocking list.

Using Call Waiting

Call Waiting, a service available from your telephone provider, lets you receive calls while you are on another call. Caller ID on Call Waiting (CIDCW) service displays Caller ID information for a waiting call.

If you get a Call Waiting call, the phone sounds a tone and displays any CID information received from the waiting call.

- For Australian Model: Press **HOME/FLASH** and then press **2** on the handset on a land line call, or press **MOBILE** on a mobile phone call to accept the waiting call. The first caller is put on hold, and you will hear the new caller after a short pause. To return to the original caller, press **HOME/FLASH** and then press **2** again or press **MOBILE** again for a mobile phone call.
- For New Zealand Model: Press **HOME/FLASH** on the land line or **MOBILE** on a mobile phone call to accept the waiting call. The first caller is put on hold, and you will hear the new caller after a short pause. To return to the original caller, press **HOME/FLASH** or **MOBILE** again.

Using Optional Headset

You can use a standard 2.5 mm telephone headset with your cordless handsets. To purchase headsets, visit our website (see the front cover).

- To install a headset, remove the headset jack cover and insert the headset plug into the jack.
- Just make and receive calls as usual, and use your headset to talk to the caller after the call connects.
- While you connect a headset, the handset automatically mutes the earpiece.

Using your Phonebooks

- You can download the phonebook (up to 1500 entries) from each paired mobile phone (up to four). You can also store up to 200 entries in the XDECT 8355's home phonebook, which is separate from any downloaded phonebooks.
- Only one cordless handset can access the phonebook at a time.

Downloading mobile phonebooks into your phone

- 1) Make sure your mobile phone is paired to the XDECT 8355 and is within range of the base.
- 2) With the XDECT 8355 in standby, open the menu and select *Bluetooth Setup*.
- 3) Select the mobile phone you want to download from, then select *Download PB*. When downloading is complete, the cordless handset

displays a confirmation screen. To cancel downloading, press **END/CLEAR**.

- Each time you download a phonebook, the XDECT 8355 overwrites any previous copy of that phonebook. The XDECT 8355 automatically cancels the download if it receives an incoming call or someone tries to make an outgoing call.
- If the download is interrupted or canceled, the XDECT 8355 reverts to the original copy of the downloaded phonebook.
- If you delete the pairing information for a mobile phone, the downloaded phonebook from that phone will also be deleted.

To..	Press...
open the phonebook	PHONEBOOK , then select Home or Mobile and then select <i>View Number</i> .
scroll through the entries	DOWN to scroll through the entries from A to Z. UP to scroll from Z to A. RIGHT to show details LEFT to return to the previous screen.
jump to entries that start with a certain letter	the number key corresponding to the letter you want.
dial this number from the land line	HOME/FLASH or SPEAKER .
dial this number from the mobile phone	MOBILE . If you have two or more mobile phones paired, select the phone you want and press MENU/SELECT .
review the current entry's details	MENU/SELECT after scrolling to the desired entry.
Use a speed dial number to open a phonebook entry	On the dial pad, press and hold the number assigned to the phonebook entry you want. The phone opens the phonebook and goes directly to that entry. Follow the instructions for dialing an entry above.
close the phonebook	END/CLEAR .

You can perform the following functions on each individual mobile phonebook entry.

First, press phonebook and select the relevant paired mobile phone. Then select the option, *View Number*, to view the downloaded contact list and refer to the table below for further options.

To..	Press...
save this mobile phonebook entry to the home phonebook	MENU/SELECT twice to open the menu, then select <i>Store Into PB</i> .
edit the current entry	MENU/SELECT twice to open the menu, then select <i>Edit</i> .
delete the current entry	MENU/SELECT twice to open the menu, then select <i>Delete</i> . To confirm, select <i>Yes</i> .

Adding Phonebook Entries (Home only)

With the phone in standby, open the phonebook. Select *Home* and then *Create New*. Enter a name and number and select a personal ring.

- Enter the phone number (up to 32 digits) exactly as you would dial it.
- If you need the phone to wait before sending the next set of digits, press **REDIAL/PAUSE** to insert a 2-second pause. You can insert multiple pauses, but each one counts as a digit (you'll see *P* in the display).
- To edit the name, press **PHONEBOOK** to move the cursor back and insert a letter. Press **END/CLEAR** to delete a letter.
- To edit the number, press **END/CLEAR** to back up the cursor and delete numbers. Re-enter the correct numbers.

Speed Dial

1. With the phone in standby, open the phonebook and select the option *Speed Dial*. The speed dial numbers correspond to the numbers (0 through 9) on the twelve key dial pad.
2. Select any number, depending on which key you want that particular contact number to correspond to, and press **MENU/SELECT**.
3. The options, *Registration* and *Delete*, display on the LCD.
4. Select the option, *Registration* and press **MENU/SELECT**. The phonebook for the handset and the mobile phones (connected to that phone) will display.
5. Select the relevant phonebook and choose the desired contact number. Press **MENU/SELECT** to save.

- Each speed dial number can be assigned to only one entry.
- If the speed dial number is already assigned, the phone shows the name of the entry assigned to the number. If you want to change it, select the number, and the phone overwrites the existing assignment.

Deleting All the Phonebook Entries

With the phone in standby, open the phonebook. Select the phone name and then *Delete All*. To confirm, select *Yes*.

Chain Dialing

If you often have to enter a series of digits or a code number during a call, you can save that code number to a phonebook entry and use the phonebook to send the code number.

- 1) Make your call normally.
- 2) When you hear the prompt that tells you to enter the number, open the phonebook and find the entry that contains your code number.
- 3) Press **MENU/SELECT** twice to send the code. If you change your mind, just close the phonebook.

USING SPECIAL FEATURES

Power Failure Back Up System

When a power failure occurs, the charged handset temporarily supplies power to the base unit. You can then make and receive calls using a handset. However, none of the keys on the base unit are functional during the power failure mode.

When a power failure occurs, place the charged handset on the base, the handset LCD backlight is illuminated for about 10 secs and the message “*Supplying power Handset >> Base*” is displayed on the LCD.

After that the message “*Please don't pick up the handset*” is displayed on the LCD.

If the handset is lifted from the base during the power back up mode, the message “*Out of Range*” will be displayed on the LCD.

If the battery level is low, the unit will not work efficiently during the power failure mode. In addition, in case the handset battery power runs out, we recommend connecting a corded-type telephone to the same telephone line.

Making Calls

To make a call during the power failure mode, follow the steps given below:

1. Taking care not to lift the handset from the base, press **HOME/FLASH** (the speakerphone is turned on automatically). Dial the number.
2. After you finish, press **END/CLEAR**.

When more than one handset is registered:

- You should leave one handset on the base unit for supplying the power, and use another handset for making calls. Please refer to the “Using your Phone” section on page 26 for details.
- During a call with the handset placed on the base unit (power back-up mode), the call may be disconnected if you touch the handset. In such a case, try to call back.
- The range of the base unit is limited during a power failure. Please use the handset close to the base.

Redial List/Phone book

1. Place the handset on the base and press **REDIAL/PAUSE** or phonebook icon.
2. Press the ▲ or ▼ key and select the desired number.
3. Press **HOME/FLASH** to dial out the number.

✗ **Some of the functions are not available under the power failure back up system. Examples are:**

- You cannot edit the phonebook (For eg, store a number).
- Redial/CID will not be stored.
- You cannot operate the Answering System
- You cannot operate the Bluetooth function.

DND (Do Not Disturb)

You can silence the ringers on the base and all handsets for a specific period of time.

- 1) With the phone in standby, press and hold **#DND** on any handset. The phone prompts you to select the number of hours (1 - 9 or *Always On*) that you want it to stay in DND mode.
- 2) To confirm, press **MENU/SELECT** or just wait about 5 seconds. The phone displays *Do Not Disturb* on each handset.
- 3) After the selected number of hours, the phone automatically exits DND mode. To exit DND mode manually, press and hold **#DND** again.

Multihandset Features

✎ **To use the features in this section, you need at least 2 handsets.**

You can register up to 12 handsets to a base (the 1 that comes with the base plus 11 additional handsets). However, only 2 handsets maximum can connect to a call at one time.

You must register accessory handsets to the base before using them. (Handsets that came packaged with the base are already registered.)

Handsets that aren't registered display a *Not Registered* message. For registration instructions, see page 49 or see the accessory handset manual.

If a handset was ever registered to a base, you must reset it before it can register to a new base; see page 49, or see the accessory handset manual.

Conference Calling (Line 1)

- A land line call or a mobile call (1 line) can be connected in conference with 2 handsets and a base creating a 4 way conference.
- To join a call that's already in progress, just press **HOME/FLASH** (to join a Landline call) or **MOBILE** (to join a Mobile call).
- To leave the conference call, hang up normally; the other handset remains connected to the call.

Conference Calling (Line 2)

A land line call AND a mobile call (2 lines) can be connected together in conference with up to 2 handsets and a base, creating a 5-way conference.

- First, use 1 handset to dial/answer your first call (by pressing either **HOME/FLASH** or **MOBILE**).
- Then, using the same handset, dial/answer your second call by pressing **HOME/FLASH** or **MOBILE**. The first call will then be put on hold.

✎ **If your first call is via the land line, your second call has to be via the mobile, and vice versa.**

- When you are connected and talking to the second call, join both your calls by pressing **MENU/SELECT** and then selecting *Conference*. You are now on 3-way conference.
- Then, 1 additional handset can join this 3-way conference by pressing either **HOME/FLASH** or **MOBILE** to create a 4-way conference.
- The base can join this 4-way conference by pressing either **HOME** or **MOBILE** to create a 5-way conference.

- ✗ You cannot set up 5-way conference by dialing or answering your first call on one handset and then the second call on another handset.
- ✗ Line conference with 2 outside lines (1 landline and 1 mobile line) has to be dialed/answered by one handset creating a 3-way conference first, before the additional handset and base in your home can join in to create 5-way conference.

Privacy Mode

To activate privacy mode on a land line call in progress, press **MENU/SELECT**. As long as privacy mode is on, you'll see a  in the display, and no other handsets can join your call. Privacy mode turns off automatically when you hang up; you can also turn it off by pressing **MENU/SELECT** twice.

To use privacy mode during a conference call, wait until all handsets have joined the call before turning on privacy mode. If a handset disconnects, that handset cannot rejoin the call as long as privacy mode remains on.

Room Monitor

This feature allows you to monitor sounds in another room. Place a handset in the room you wish to monitor; it will function as a microphone. A second handset/base can be used as a remote speaker, allowing you to monitor sounds in the room.

Using Room Monitor

To enter the Room Monitor mode, press **MENU/SELECT** and then select *Room Monitor*. Press **END/CLEAR** on the handset or **PLAY/STOP** on the base when you want to stop monitoring.

Call Transfer

To change the...	On the Landline...	Using the Mobile Phone...
Transfer a call	Press MENU/SELECT and choose <i>Hold/Transfer</i> from Handset or press INTERCOM/FIND HS on the Base. The phone puts the call on hold and prompts you to select the handset you want to page. When the other handset accepts the call, you'll be disconnected (press HOME/FLASH to rejoin the call).	
cancel a transfer	Press END/CLEAR .	
return to the call	Press HOME/FLASH .	Press MOBILE .

answer a call transfer page	Press HOME/FLASH . You can speak to the transferring handset.	
	To speak to the outside caller,	
	Press HOME/FLASH again.	Press MOBILE .

Intercom

- Whenever the phone is in standby, you can make an intercom call between handsets without using the phone line.
- You can make an intercom call from any handset, but only two handsets can be in an intercom call at any time.
- If an outside call comes in during an intercom page, the phone cancels the page so you can answer the incoming call.
- If an outside call comes in during an intercom call, press **HOME/FLASH** or **MOBILE**, depending on which line is ringing, to hang up the intercom call and answer the outside call.

To	Press
make an intercom page	Press MENU/SELECT and choose Intercom from Handset or press INTERCOM/FIND HS on the Base. Select the handset/base you want to talk with, or <i>ALL</i> to page all handsets at the same time.
cancel a page	END/CLEAR
answer a page	HOME/FLASH
end an intercom call	END/CLEAR . Both handsets return to standby.

Voice Message Notification

If you subscribe to a voice mail service, your phone can notify you when you have a new message. This feature supports Frequency-Shift Keying (FSK) notification. Contact your voice mail provider for information.

When you have new messages, the display shows a message icon and the charge LED on the handset blinks. To access your voice mail, press **MESSAGE/MUTE** and select *Voice Mail*.

 **When you select *Voice Mail*, you will be prompted to enter a Voice Mail Access number if you have not yet set one up (see page 24). If you have already set one up, your phone will dial it.**

After you listen to all your messages, the message icon turns off and the charge LED on the handset stops blinking. If it doesn't, you can reset it: With the phone in standby, open the menu and select *Global Setup*; select *VMWI Reset*, then select *Yes*.

USING THE ANSWERING SYSTEM

📞 The answering system works with landline calls only.

Answering System Options (Answering Setup)

You can set or change the answering system options from any handset or from the base. Just open the menu and select Answering Setup.

Select this option...	To...
Security Code	Enter a 2-digit PIN so you can access your answering system from any touch-tone phone (see page 44).
Ring Time	Set the number of rings (6, 9, or 12) before the system answers. Toll Saver makes the system answer after 2 rings if you have new messages or after 4 rings if you don't.
Record Time	Set the amount of time (1 or 4 minutes) callers have to leave a message. Choose Announce Only if you don't want the system to let callers to leave a message.
Message Alert	Have the system beep every 15 seconds when you have a new message. The alert stops after you listen to all your new messages or if you press any key on the base.
Call Screen	Turn on the call screen feature so you can hear callers as they leave messages on the base speaker (see page 44).
Ans. On/Off	Turn your answering system on or off. You can also press ANSWER ON/OFF on the base.
Record Greeting	Record an outgoing message or greeting (see page 42).
Greeting Options	Switch greetings or delete your greeting (see page 42).

Personalize the Greeting

Your personal outgoing message or greeting can be from 2 to 30 seconds long. If you don't record a greeting, the system uses a pre-recorded greeting: *Hello, no one is available to take your call. Please leave a message after the tone.*

To...	Follow these steps
Record your personal outgoing message or greeting	<ol style="list-style-type: none">1. Open the menu with the phone in standby. Select <i>Ans.Setup</i>, then <i>Record Greeting</i>.2. Press MENU/SELECT to start recording. Wait until the system says "Record greeting" before speaking.3. Press MENU/SELECT to stop recording. The system plays back your new greeting and save it.
Switch between the pre-recorded greeting & your own greeting	<ol style="list-style-type: none">1. Open the menu with the phone in standby. Select <i>Ans. Setup</i>, then <i>Greeting Options</i>.2. The system plays back the current greeting. Press MENU/SELECT to switch greetings.
Delete your greeting	<ol style="list-style-type: none">1. Switch to your personal greeting following the steps above.2. While the system is playing back your greeting, press END/CLEAR on the handset or DELETE on the base.

Accessing the Answering System

When the phone's in standby, you can access the system from any handset; however, only 1 handset can access the system at a time. During remote access:

- If you do nothing for 30 seconds, the phone returns to standby.
- During message playback, you can press the number key shown next to each command instead of scrolling through the screens.

Play All Messages

To...	From the base	From a handset (Optional)
<i>play new messages</i>	Press PLAY/STOP	Press MESSAGE and select <i>Play Messages</i> .
	The system announces the number of new & old messages, then plays each new message (followed by the day and time) in the order it was received. After the new messages play, the system plays the old messages.	
<i>restart this message</i>	Wait at least 5 seconds after the message starts playing,	
	press PHONEBOOK/LEFT .	press 1 (number key).
<i>replay an earlier message</i>	Within 2 seconds after a message starts playing,	
	press PHONEBOOK/LEFT	Press 1 (number key).
<i>skip a message</i>	Press CID/RIGHT .	Press 3 (number key).
<i>delete a message</i>	While a message is playing, press DELETE .	While a message is playing, press 4 (number key).
<i>delete all messages</i>	With the phone in standby, press DELETE ; press DELETE again to confirm.	Not available.
<i>play old messages</i>	After the system plays all new messages,	
	press PLAY/STOP again.	Press 2 (number key).
<i>stop playback</i>	Press PLAY/STOP .	Press 5 (number key).

Screening Your Calls

You can use the answering system for call screening. While the system takes a message, you can listen on the base speaker (if you turn on Call Screen) or from a handset. Only one handset can screen calls at a time. If another handset tries to screen calls, it beeps and returns to standby.

To...	From the Base	From a Handset (Optional)
<i>hear the caller leaving a message</i>	Listen to the caller over the speaker.	Press MESSAGE .
<i>answer the call</i>	Press SPEAKER	Press HOME/FLASH .
<i>mute the call screen without answering*</i>	Press PLAY/STOP .	Press END or return the handset to the cradle.

*If you mute the call screen, the system continues taking the message: it just stops playing through the speaker.

Using the System While You're Away from Home

You can dial in to your answering system from any touch-tone phone.

Before you can use this feature, you must program a security code.

Programming a Security Code

With the phone in standby, open the menu; select *Answering Setup*, then select Security Code. Use the number keypad to enter a two-digit security code (01 to 99). Press **MENU/SELECT** when you're finished.

🔒 **Remember to make a note of your new security code!**

Dialing In to Your System

1. Call your phone number and wait until the system answers. (If the system is turned off, it answers after 15 rings and sounds a series of beeps.)
2. During the greeting or beeps, press # and immediately enter your security code. If you enter it incorrectly 3 times, the system hangs up and returns to standby.
3. The system announces the time, the number of messages in memory, and a help prompt. It beeps to let you know it's waiting for a command.
4. When you hear beeping, enter a 2-digit command from the chart.

#1	Repeat message	#5	Stop playback
#2	Play message	#6	Turn the system on
#3	Skip message	#9	Turn the system off
#4	Delete message	#0	Hear help prompts

- ⚠ **If you don't press any keys for 15 seconds, the system hangs up and return to standby.**

IMPORTANT INFORMATION

Solving Problems

If you have any trouble with your phone, check this section first. If you need help, visit our website listed on the front cover.

General Problems	Possible Solutions
The phone keeps ringing when I answer on an extension.	You may have to change the line mode. Contact Customer Service for instructions.
A handset can't make or receive calls.	Move the handset closer to the base.
A handset can make calls, but it won't ring.	<ul style="list-style-type: none">• Make sure the ringer is turned on.• Make sure DND mode is turned off
A handset is not working.	<ul style="list-style-type: none">• Charge the battery for 15-20 hours.• Check the battery connection.
The phone keeps ringing when I answer on an extension.	You may have to change the line mode. Contact Customer Service for instructions.
The charge LED on the handset keeps blinking while on standby.	You may have unread messages in your voicemail service with your telco. Refer page 40.
Audio Issues	Possible Solutions
Callers sound weak or soft.	<ul style="list-style-type: none">• Move the handset closer to the base.• Keep the handset's battery fully charged.• Increase the earpiece volume.

<p>There's a lot of noise or static on the line</p>	<ul style="list-style-type: none"> • Check for interference from appliances (microwave ovens, TVs, etc.) or wireless devices (baby monitors, WiFi equipment, etc.). Move the handset or base away from the interference source. • If you use a telecoil hearing aid, turn on T-coil mode (see page 23). • If you have any service that uses the phone line, add a DSL or telephone line filter (see page 48).
Caller ID Problems	Possible Solutions
<p>Caller ID information does not display.</p>	<ul style="list-style-type: none"> • Let calls ring twice before answering. • Make sure your Caller ID service is active.
Multihandset Problems	Possible Solutions
<p>I can't register a new handset.</p>	<ul style="list-style-type: none"> • Reset the handset (see page 49). • See if you have 12 registered handsets.
<p>I can't transfer calls.</p>	<p>Reset the handset (see page 49).</p>
<p>Two handsets can't talk to a caller.</p>	<p>See if any handset is in Privacy Mode.</p>
<p>A handset says <i>Unavailable</i>.</p>	<ul style="list-style-type: none"> • Move the handset closer to the base. • See if any handset is in Privacy Mode.
Answering System Problems	Possible Solutions
<p>The answering system does not work.</p>	<ul style="list-style-type: none"> • Make sure the answering system is on. • Make sure the base is plugged in.
<p>The system won't record messages.</p>	<ul style="list-style-type: none"> • See if Record Time is set to <i>Announce Only</i>. • Delete messages (memory may be full).

My outgoing message is gone.	If there was a power failure, re-record your personal outgoing message.
I can't hear the base speaker.	<ul style="list-style-type: none"> • Make sure call screening is turned on. • Change the base speaker volume.
Messages are incomplete.	<ul style="list-style-type: none"> • Increase the Record Time. • Delete messages (memory may be full).
The system keeps recording when I answer on an extension.	You may have to change the line mode. Contact Customer Service for instructions.
Bluetooth Problems	Possible Solutions
The XDECT 8355 won't pair with my phone.	<ul style="list-style-type: none"> • Making sure your phone is in pairing mode. • Check your phone's manual for instructions on Bluetooth device pairing. • Making sure your phone supports the Bluetooth hands-free profile. • Checking the link order for that phone. In rare cases, some mobile phones may not be linked as the third or fourth mobile phone.
The XDECT 8355 doesn't ring when my mobile phone does.	<ul style="list-style-type: none"> • Making sure your phone has Bluetooth turned on. • Making sure your phone is in range of the base. • Making sure the handset's ringer is not turned off. (The base doesn't ring on cellular calls.)
The XDECT 8355 paired with my phone, but I can't hear anything through the handset.	<ul style="list-style-type: none"> • Adjusting the volume. • Setting your mobile phone to transfer the audio to a Bluetooth device. Check your phone's manual for instructions on Bluetooth setup and options. • Erase the Bluetooth pairing and repair the cellular phone to the base. To erase the Bluetooth pairing, see page 27.

Installing a Line Filter or DSL Filter

A telephone line filter or DSL filter prevents services that use the phone line from causing interference on your phone. To get a line filter, contact your service provider or look in an electronics store.

Plug the filter into the telephone wall jack and plug the base into the filter. Make a test call to make sure the noise is gone.

Liquid Damage

CAUTION: If the base is covered in liquid, disconnect the adapter and phone cord from the wall before touching it.

If the liquid is only on the exterior housing of the base or handset, wipe it off and use as normal. If you can hear liquid inside the housing:

- 1) Remove all compartment covers, and disconnect all cables and cords.
- 2) If liquid is leaking from any vent or hole, turn the phone so that vent faces down. If not, place the largest vent face down.
- 3) Let dry for at least 3 days. Check for liquid inside the phone before replacing compartment covers and reconnecting cords.

Resetting Handsets

The base can register up to 12 handsets. If you have trouble with a handset or if you want to replace one, clear the registration information from the base and the handset:

- 1) Press and hold **END/CLEAR** and **#** at the same time until you see the *System Reset* menu.
- 2) If you still have the base the handset is registered to, select *Deregister HS*, then select the handset you want to reset. If you don't have that base anymore, select *Base Unavailable*.
- 3) To confirm, select *Yes*. The handset displays *Handset not registered*.

Registering Handsets

If you see a "not registered" message on a handset, you must register it to a base before using it.

- 1) Place the handset in the base; the display should say *Handset Registering*.
 - 2) Wait until the display says *Registration Complete* (about 30 seconds), then pick up the handset; press **HOME/FLASH**.
- ☒ **If you don't hear a dial tone or the display says *Registration Failed*, charge the battery completely, then try again.**

Registering Repeaters to the Base

If you are having trouble with a repeater or if you want to replace one, you need to register the repeater to the base.

✎ **Connect the repeater close to the base for easy access to the necessary buttons and indicators. Locate the repeater in the desired position after registration is complete.**

1. On the base, open the menu and select Register Accy.
2. On the back of the repeater you want to register, press and hold the registration button until the LINK light on the front starts to blink (about 2 seconds).
3. Release the button and wait for the Link light to turn on and steady (this can take about 90 seconds). The repeater has been registered to the base.

If	Try
the Link light won't turn on	<ul style="list-style-type: none">• checking the repeater's AC adaptor• connecting the adapter to a different outlet.
the link light continues flashing	<ul style="list-style-type: none">• disconnecting the unit's AC adaptor. Wait about ten seconds, then try again.• making sure there are not already 6 repeaters registered to this base.• making sure no other base or repeater is in registration mode.

- Only register one repeater at a time. If more than one repeater is in registration mode at the same time then they can interfere with each other.
- Only register a repeater to one base at a time. If more than one base is in registration mode at the same time then you can't control which base the repeater registers to.
- If you want to register two repeaters to this base, just repeat these steps with the second repeater.

USB Charge Port	
Output	5.0V/500mA

Adaptor & Battery Information

AC Adaptor	Base	Charger	Repeater (Optional)
Part number	AAD-6135	AAD-600S(R)	AAD-041S(R)
Input voltage	240V AC, 50Hz	240V AC, 50Hz	240V AC, 50Hz
Output voltage	6V DC @ 500mA 7V DC @ 800mA	9V DC @ 210mA	9V DC @ 350mA

- Use only the supplied AC adaptors.
- Use the proper adaptor for the base and any chargers.
- Do not place the unit in direct sunlight or subject it to high temperatures.

Battery Pack (with normal use)	
Part number	BT-694 or BT-694s
Capacity	650mAh (BT-694) or 500mAh (BT-694s)
Talk time	up to 10 hours
Standby time	up to 10 days
Battery life	up to 1 year

- Replace the battery when the talk or standby time becomes noticeably reduced. For replacements, visit the online shop on our website (see the front cover).
- When the battery gets low, the handset beeps and shows a low battery alert; put the handset in the cradle for recharging.

Rechargeable Battery Warning

- This equipment contains a rechargeable Nickel-Metal-Hydrate (Ni-MH) battery.
 - Do not short-circuit the battery.
 - The batteries in this equipment may explode if disposed of in a fire.
 - Do not charge the batteries in any charger other than the one specified in the owner's manual. Using another charger may damage the battery or cause it to explode.
- ♻️ **Rechargeable batteries must be recycled or disposed of properly.**
- ♻️ **Uniden works to reduce lead content in our products and accessories.**

INDEX

- A**
Answering System 41
Auto Talk 24
Any Key Answer 24
- B**
Banner 24
Battery 51
Bluetooth 14
- C**
Caller ID 30
Call Transfer 39
Call Waiting 32
Chain Dialing 35
Clock 25
Conference Calling 38
- D**
Date & Time 25
Do Not Disturb (DND) 37
- E**
Earpiece Volume 29
- H**
Headset 32
- I**
Intercom 40
- K**
Key Touch Tone 24
- L**
LCD Contrast 24
Line Conference 38
Line Filter 49
Liquid Damage 49
- M**
Multihandset Feature 38
Mute 20
- N**
Noise 49
- P**
Paging Handsets 40
Personal Ring 24
Phonebook 32
Power Failure Backup 36
Privacy Mode 39
- R**
Registering the handset 49
Register the Repeater 50
Repeater 10
Ringer 24
Ringer Volume 29
Room Monitor 39
- S**
Speaker Volume 29
Speed Dial 34
Static 47
- V**
Voice Mail 40
- W**
Warranty 53

ONE-YEAR LIMITED WARRANTY

XDECT 8355

IMPORTANT Satisfactory evidence of the original purchase is required for warranty service

Please refer to our Uniden website for any details or warranty durations offered in addition to those contained below.

Warrantor

The warrantor is Uniden Australia Pty Limited ABN 58 001 865 498.

Terms of Warranty

Uniden Aust warrants to the original retail purchaser only that the XDECT 8355 (“the Product”), will be free from defects in materials and craftsmanship for the duration of the warranty period, subject to the limitations and exclusions set out below.

Warranty Period

This warranty to the original retail purchaser is only valid in the original country of purchase for a Product first purchased either in Australia or New Zealand and will expire one (1) year from the date of the original retail sale.

If a warranty claim is made, this warranty will not apply if the Product is found by Uniden to be:

- (A) Damaged or not maintained in a reasonable manner or as recommended in the relevant Uniden Owner’s Manual;
- (B) Modified, altered or used as part of any conversion kits, subassemblies or any configurations not sold by Uniden Aust;
- (C) Improperly installed contrary to instructions contained in the relevant Owner’s Manual
- (D) Repaired by someone other than an authorized Uniden Repair Agent in relation to a defect or malfunction covered by this warranty; or
- (E) Used in conjunction with any equipment, parts or a system not manufactured by Uniden.

Parts Covered

This warranty covers the Product and included accessories.

User-generated Data

This warranty does not cover any claimed loss of or damage to user-generated data (including but without limitation phone numbers, addresses and images) that may be stored on your Product.

Statement of Remedy

If the Product is found not to conform to this warranty as stated above, the Warrantor, at its discretion, will either repair the defect or replace the Product without any charge for parts or service. This warranty does not include any reimbursement or payment of any consequential damages claimed to arise from a Product's failure to comply with the warranty.

Our goods come with guarantees that cannot be excluded under the Australian Consumer Law. You are entitled to a replacement or refund for a major failure and for compensation for any other reasonably foreseeable loss or damage. You are also entitled to have the goods repaired or replaced if the goods fail to be of acceptable quality and the failure does not amount to a major failure.

This warranty is in addition to and sits alongside your rights under either the COMPETITION AND CONSUMER ACT 2010 (Australia) or the CONSUMER GUARANTEES ACT (New Zealand) as the case may be, none of which can be excluded.

Procedure for Obtaining Warranty Service

Depending on the country in which the Product was first purchased, if you believe that your Product does not conform with this warranty, you should deliver the Product, together with satisfactory evidence of your original purchase (such as a legible copy of the sales docket) to Uniden. Please refer to the Uniden website for address details. You should contact Uniden regarding any compensation that may be payable for your expenses incurred in making a warranty claim. Prior to delivery, we recommend that you make a backup copy of any phone numbers, images or other data stored on your Product, in case it is lost or damaged during warranty service.

UNIDEN AUSTRALIA PTY LTD

Phone number: 1300 366 895

Email: custservice@uniden.com.au

Uniden®

©2016 Uniden Australia Pty Ltd
Printed in PRC U01UN624BZZ(0)